

Topic 4. Introduction to Communication Systems

Telecommunication Systems Fundamentals

Profs. Javier Ramos & Eduardo Morgado

Academic year 2.013-2.014

Concepts in this Chapter

- *General Overview*
 - *Logarithmic Units (dB) and Link Budget*
 - *Review of fundamental parameters of physical layer: bandwidth, BER, SNR, Rate...*
 - *Other merit figures: Quality of Service*
 - *A/D Converter*
 - *Circuit Commutation vs. Packet Commutation*
 - *Network Topologies*
- *Functional Block Diagram of Analog Communications link*
- *Functional Block Diagram of a Digital Communications Link*
 - *Block description*
 - *Digital Modulations*
 - *Multiplexing and Multiple Access*

Theory classes: 3 sessions (6 hours)

Problems resolution: 1 session (2 hours)

Lab (Matlab): 2 hours

Bibliography

Communication Systems Engineering. John. G. Proakis. Prentice Hall

Sistemas de Comunicación. S. Haykin. Wiley

Digital Communications. Fundamentals and Applications. B. Sklar. Prentice Hall

Digital Communications. J. G. Proakis. McGraw-Hill

Communications Systems. A. Bruce Carlson y Paul B. Crilly. Mc Graw Hill

Logarithmic Units (dB)

- When measuring a physical magnitude, we have to provide two pieces of information: a quantity (typically a number either integer or real) and the units. For example, when measuring the diameter of a tennis ball, we provide the number 6 but also the units “cm” (centimeters). In this example, the measurement of the diameter of the tennis ball is 6 cm. If we change units the number of the measurement – the quantity – will also change. In our example the diameter ball may be 60 mm, or 0.00006 Km.
- Obviously the adequate selection of units helps the handling of measurements. In our example, to measure the tennis ball the unit “cm” seems to be adequate, but when measuring the Earth radius the unit “Km” seems to be more appropriate. More extreme is the case of measuring the Sun radius. If we use the same units – meters – for the three measurements, we would get 0,06 m, 12.756.000 m and 1.392.000.000 m for the tennis ball, Earth and Sun respectively.
- Having so extreme differences on the measurements results in practical problems. For example, try to plot the three measurements in the same graph. If you take a scale to accommodate the Sun radius, the radius of the tennis ball will appear as negligible (cero), but it is not.

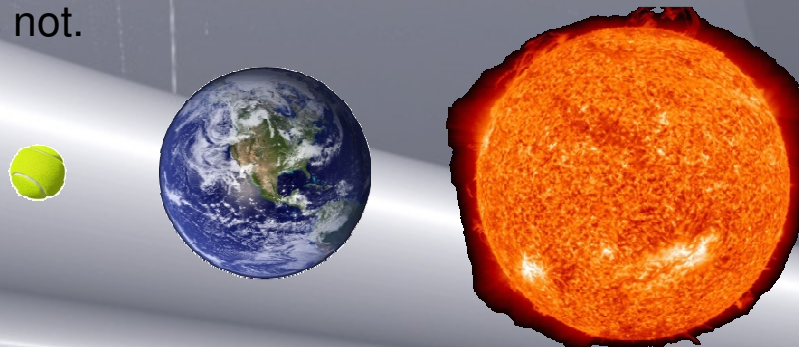

Logarithmic Units (dB)

- To solve the previous problem the Logarithmic Units can be used. As an example, we can define the “Logarithmic-meter” (Lm) as
$$X(mL) = \log(x(m))$$
- Let see the dimension of the tennis ball, Earth and Sun with this new Unit
$$D_{\text{tennis}} = -1,2 \text{ Lm}$$
$$D_{\text{Earth}} = 7,1 \text{ Lm}$$
$$D_{\text{Sun}} = 9,1 \text{ Lm}$$
- Now, different sizes have different values, but they are in the same range and therefore we can plot them in the same graph without losing information.

Logarithmic Units (dB)

- ***Advantages of the usage of Logarithmic Units***

- Main advantage of the usage of Logarithmic Units is the ability to represent large variations of magnitudes within relatively low precision figures.
- Additionally, the multiplication of two magnitudes became an addition when they are expressed on Logarithmic Units. Specially in electronic and telecommunications, gains and attenuations go from multiplying by a number, when in natural units, to sum a number, when in logarithmic units, which simplifies quick calculations.

Output (Volts) = Input (Volts) * Gain (non-dimensional)

Output (LV) = Input (LV) + Gain (L-non-dimensional)

Logarithmic Units (dB)

- **Logarithmic Units used in Engineering**

- **dBW: to measure power (watts):** $P(\text{dBW}) = 10 \cdot \log(p(W))$

$$p(W) = 10^{P(\text{dBW})/10}$$

- **dBm: power in miliWatts:** $P(\text{dBm}) = 10 \cdot \log(p(\text{mW}))$

$$p(\text{mW}) = 10^{P(\text{dBm})/10}$$

note that obviously $x (\text{dBW}) = x + 30 (\text{dBm})$

- **dBV: to measure amplitude of electrical signals (volts) :**

$$A(\text{dBV}) = 20 \cdot \log(a(V))$$

Note that here we use a factor of 20, while in the power logarithmic units we use a factor of 10

- **dBu or dB μ : amplitude referred to microvolt:**

$$A(\text{dBu}) = 20 \cdot \log(a(\mu V))$$

note that obviously $x (\text{dBu}) = x + 120 (\text{dBV})$

All the above units can be also read as “decibels” [watts/miliwatts/volts/microvolts]

Logarithmic Units (dB)

- Decibels can be used to express ratios between two magnitudes with the same units – so to express non-dimensional quantities.

Let be two measurements of power $p1$ W and $p2$ W. The ratio between the two measurements can be expressed as

$$G(\text{dB}) = 10 \cdot \log(p1(W) / p2(W))$$

If $p1$ is the power at the output of an amplifier, and $P2$ is the input power, then G corresponds with the gain of that amplifier

Note that $\log(a/b) = \log(a) - \log(b)$, so

$$G(\text{dB}) = 10 \cdot \log(p1(W) / p2(W)) = 10 \cdot \log(p1(W)) - 10 \cdot \log(p2(W)) = P1 (\text{dBW}) - P2 (\text{dBW})$$

- The gain of the amplifier can be computed by resting output power minus input power, both expressed on dBW
- Any “dBx” unit can be seen as the ratio between the given measurement and “x”

Logarithmic Units (dB)

- Side Notes about dB's

- Usually we note natural units with lowercase letters, and logarithmic units with capital letters
- 0 dBW means 1w of power – beginner mistake is to consider 0dBW as zero-power.

$$10 \cdot \log(1 \text{ W}) = 0 \text{ dBW}$$

- Power expressed on dBm is 30 dB larger than in dBW :

- $P(\text{dBm}) = 10 \cdot \log(p(\text{mW})) = 10 \cdot \log(p(\text{W}) \cdot 1000) = 10 \cdot [\log(p(\text{W})) + \log(1000)] = P(\text{dBW}) + 10 \cdot \log(1000) = P(\text{dBW}) + 30$

- Positive definite quantities can be negative when they are expressed in dB – this is the case of the power
- Two important properties of logarithms will be often used:

$$\log(a \cdot b) = \log(A) + \log(B)$$

$$\log(a/b) = \log(A) - \log(B)$$

therefore when two magnitudes are multiplied, the result expressed on dBs corresponds with the sum of the individual magnitudes expressed on dBs. This is the example to compute the output power of an amplifier. Let and input signal of 1w that passes through and amplifiers of gain 10, the output power is:

$$P_{\text{amplificada}}(\text{dBW}) = 10 \cdot \log(1\text{W}) + 10 \cdot \log(10) = 0 \text{ dBW} + 10 \text{ dB} = 10 \text{ Dbw}$$

- Be extremely careful with the addition of magnitudes when the are expressed on dB's

Logarithmic Units (dB)

- Among many other applications in engineering, logarithmic units are applied to compute available powers along a transmission chain. The evolution of the signal power along the transmission chain depends on cable attenuation, amplifier gain, connector losses, etc.
- Example: we have a transistor that generates a signal with 1W of power. The signal goes through a cable that attenuates the signal to half its power and an antenna that focuses the radiation towards a direction equivalently to increase signal's power by a factor of 10. The calculus of the final power is
 - Natural units:
$$p_{final} = (p_{tx} / cable_loss) * antenna_gain = 1W / 2 * 10 = 5 W$$
 - Logarithmic units:
$$P_{tx} = 10 \cdot \log(1W) = 0 \text{ dBW}$$

$$L_{cable} = 10 \cdot \log(cable_loss) = 3 \text{ dB}$$

$$G_{antenna} = 10 \cdot \log(antenna_gain) = 10 \text{ dB}$$

$$P_{final} \text{ (dBW)} = P_{tx} \text{ (dBW)} - L_{cable} \text{ (dB)} + G_{antenna} \text{ (dB)} = 7 \text{ dBW}$$
- *The actual calculus may be more complex, but attenuations, losses, gains, etc are usually expressed in dB by manufacturers. So, it will be easier to use dB's in calculations*

Concepts in this Chapter

- *General Overview*
 - *Logarithmic Units (dB) and Link Budget*
 - *Review of fundamental parameters of physical layer: bandwidth, BER, SNR, Rate...*
 - *Other merit figures: Quality of Service*
 - *A/D Converter*
 - *Circuit Commutation vs. Packet Commutation*
 - *Network Topologies*
- *Functional Block Diagram of Analog Communications link*
- *Functional Block Diagram of a Digital Communications Link*
 - *Block description*
 - *Digital Modulations*
 - *Multiplexing and Multiple Access*

Quality of Service (QoS)

- It is not only about sending information from one site to other, but doing it with a minimum of quality – as any other engineering task

What is the relevant information in the transmitted signal?

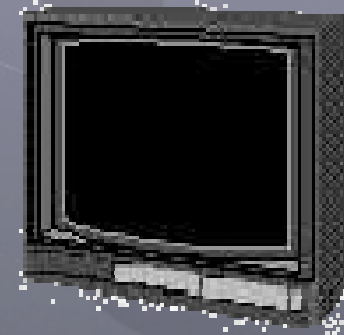

What Quality for those signal parameters should I expect or demand?

Quality of Service (QoS)

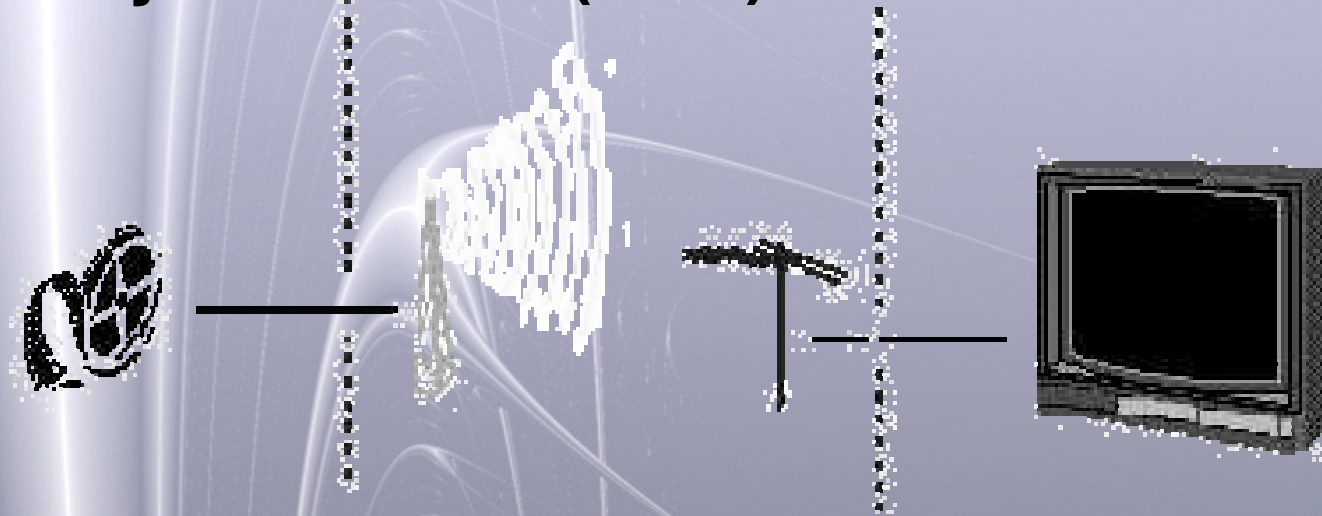

What is sent? : Information

Characteristics of the signal:

Type of info:

Magnitude (light, electromagnetic field, sound, ...)

Analog or Digital

Redundancy

Bandwidth (Tx rate)

Transmitted power

Time distribution

Amplitude distribution

QoS defining parameters:

Analog signal

Noise

Distortion

Interference

SNR

Digital

Bit Throughput

Bit Error Probability (BER)

Delay (jitter)

Quality of Service (QoS)

- Channel parameters that affect the QoS
 - Bandwidth
 - Definition of Bandwidth for non-ideal channels (3dB, 90% of power, first null)
 - Types of channel depending of its band-pass (low-pass, band-pass, high-pass, band-stopped)
 - Attenuation (dB)
 - Noise Figure
 - Thermal noise
 - Interferences
 - Noise Equivalent Bandwidth
 - Linear Distortion
 - Amplitude and phase distortion
 - Non-Linear Distortion
 - Dynamic Range

Concepts in this Chapter

- *General Overview*
 - *Logarithmic Units (dB) and Link Budget*
 - *Review of fundamental parameters of physical layer: bandwidth, BER, SNR, Rate...*
 - *Other merit figures: Quality of Service*
 - *A/D Converter*
 - *Circuit Commutation vs. Packet Commutation*
 - *Network Topologies*
- *Functional Block Diagram of Analog Communications link*
- *Functional Block Diagram of a Digital Communications Link*
 - *Block description*
 - *Digital Modulations*
 - *Multiplexing and Multiple Access*

Analogue vs Digital Transmission

- Analogue



Signal in a traditional Telephone cable

- Digital

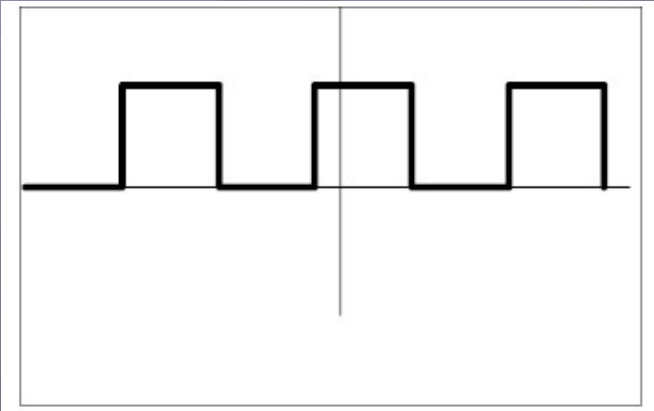
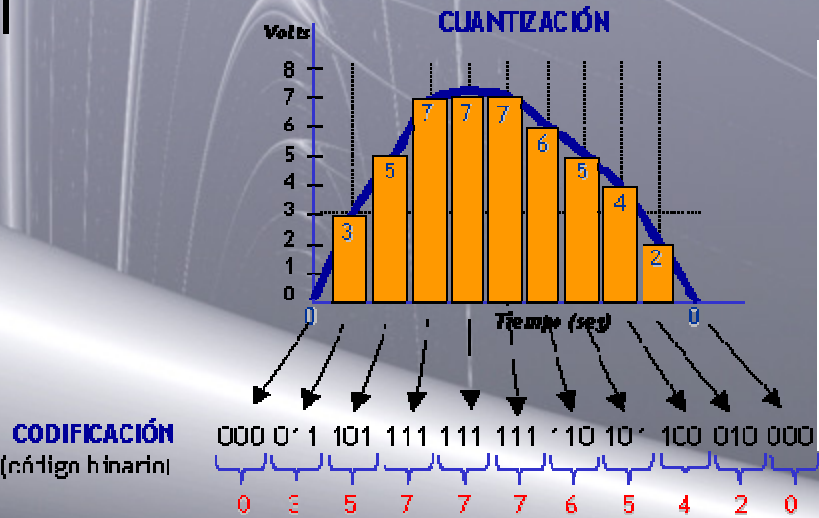

Advantages of the Digital Systems

Technologic Factors

- Simplicity
- Integration of multiple systems
- Source independent
- Easier multiple access

Systemic Factors

- Convergence of multiple systems in only one Hw

Economic Factors

- Derived of above factors
- Repeatability and scalability

Analogue vs Digital Transmission

- Analogue

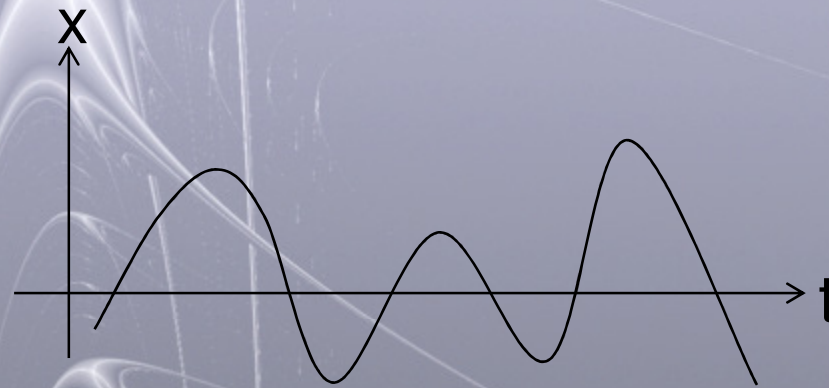

- Digital

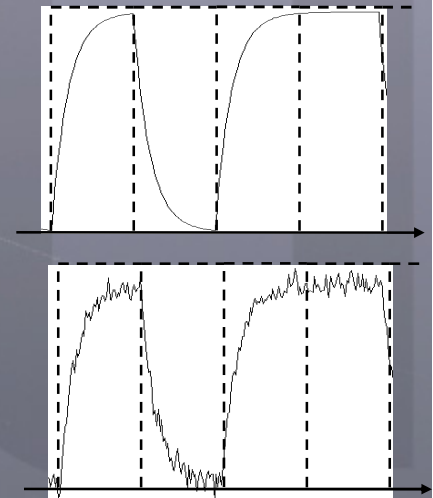

Analogue vs Digital Transmission

- Possibility of regenerative amplification in digital transmission

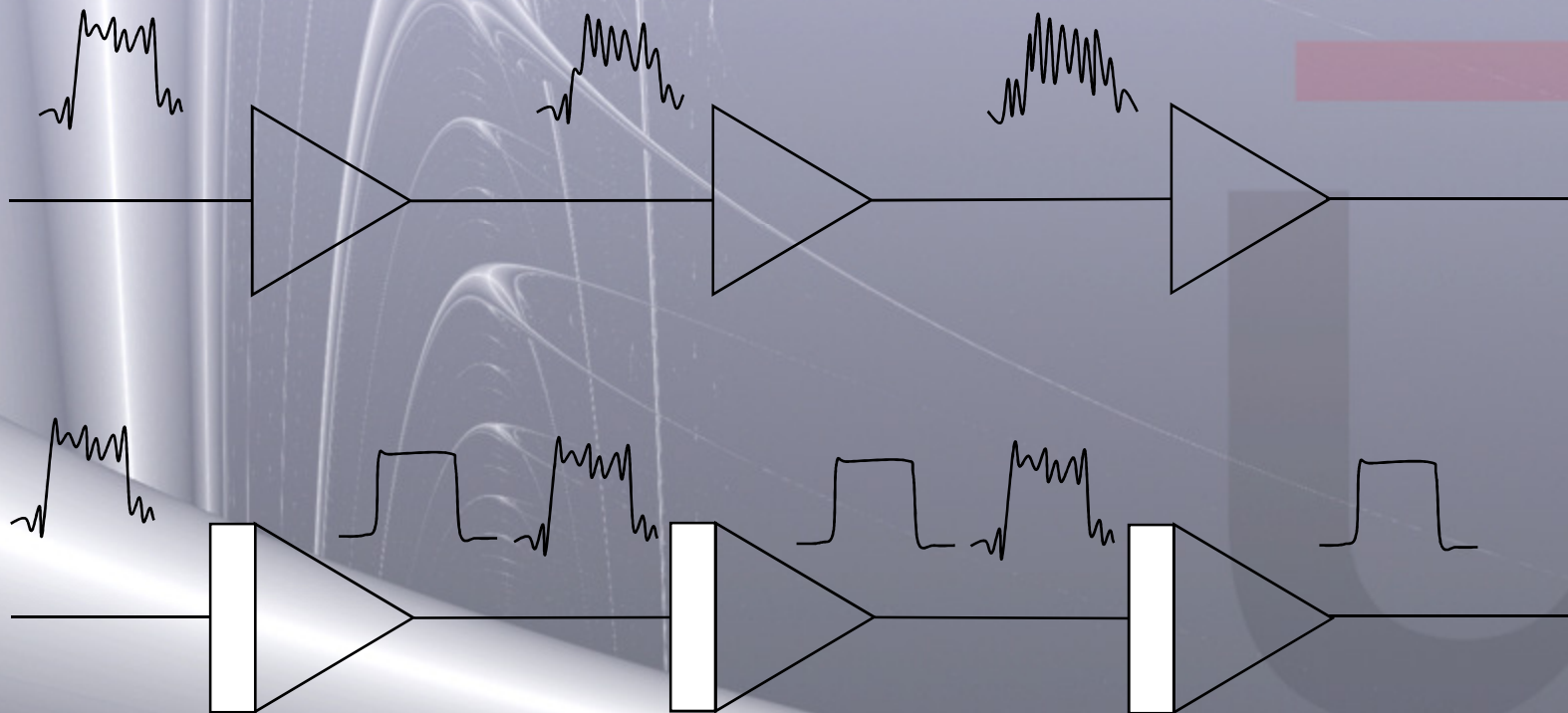

Advantages of the Digital Systems

- Easier multiple access

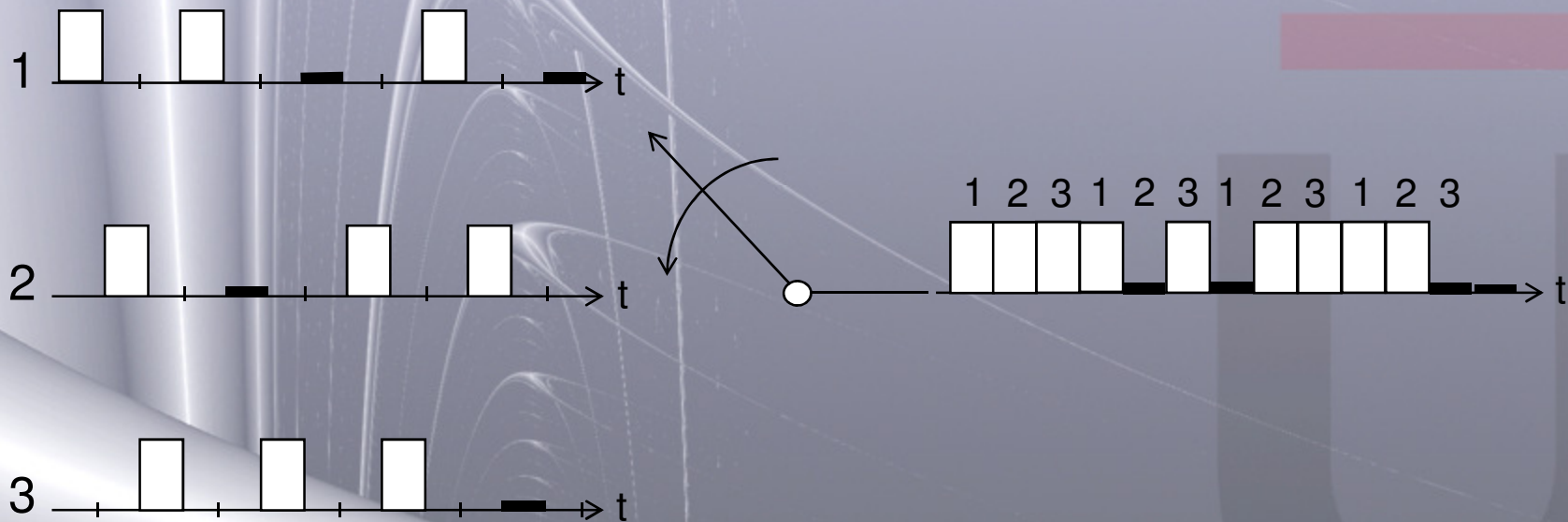

Analogue to Digital Conversión

- 3 Steps (first approach using traditional PCM – Pulse Coded Modulation):

– 1: Sampling

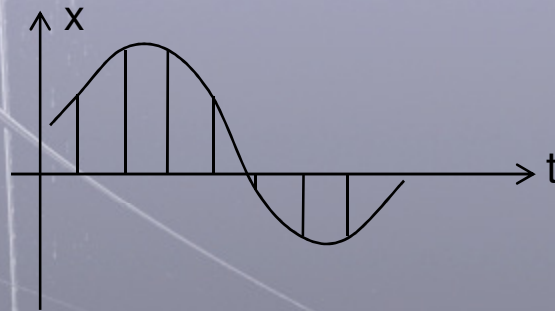

– 2: Quantification

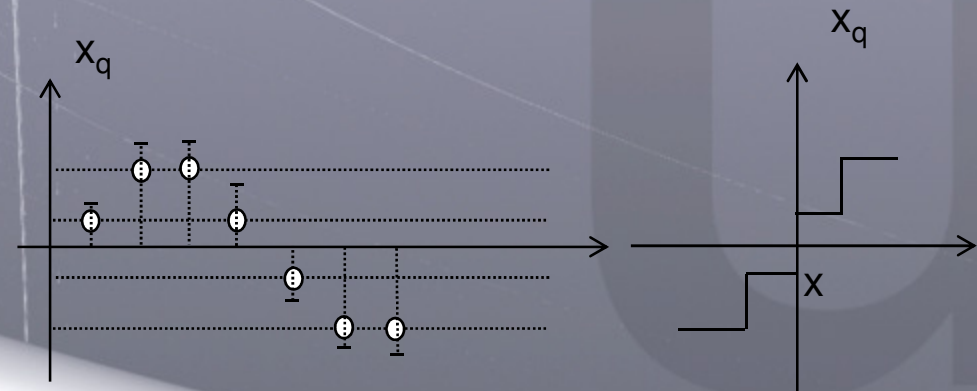

Analogue to Digital Conversión

– 3: Coding

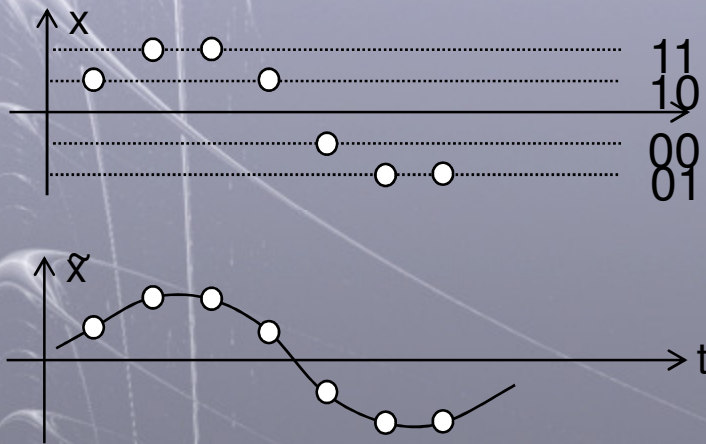

More Efficient Analogue to Digital Conversions

- Differential PCM
- Delta-Coding
- Sub-Bands Coding
- Compression and lossy coding

Concepts in this Chapter

- *General Overview*
 - *Logarithmic Units (dB) and Link Budget*
 - *Review of fundamental parameters of physical layer: bandwidth, BER, SNR, Rate...*
 - *Other merit figures: Quality of Service*
 - *A/D Converter*
 - *Circuit Commutation vs. Packet Commutation*
 - *Network Topologies*
- *Functional Block Diagram of Analog Communications link*
- *Functional Block Diagram of a Digital Communications Link*
 - *Block description*
 - *Digital Modulations*
 - *Multiplexing and Multiple Access*

Switched Communications Networks

- Long distance transmission between stations (called “subscribers”) is typically done over a network of **switching nodes**
- Switching nodes purpose is to provide a path for the info to reach its destination
- A collection of nodes and connections forms a network
- In a switched network, data entering the network from a station are **routed** to the destination by being switched from node to node

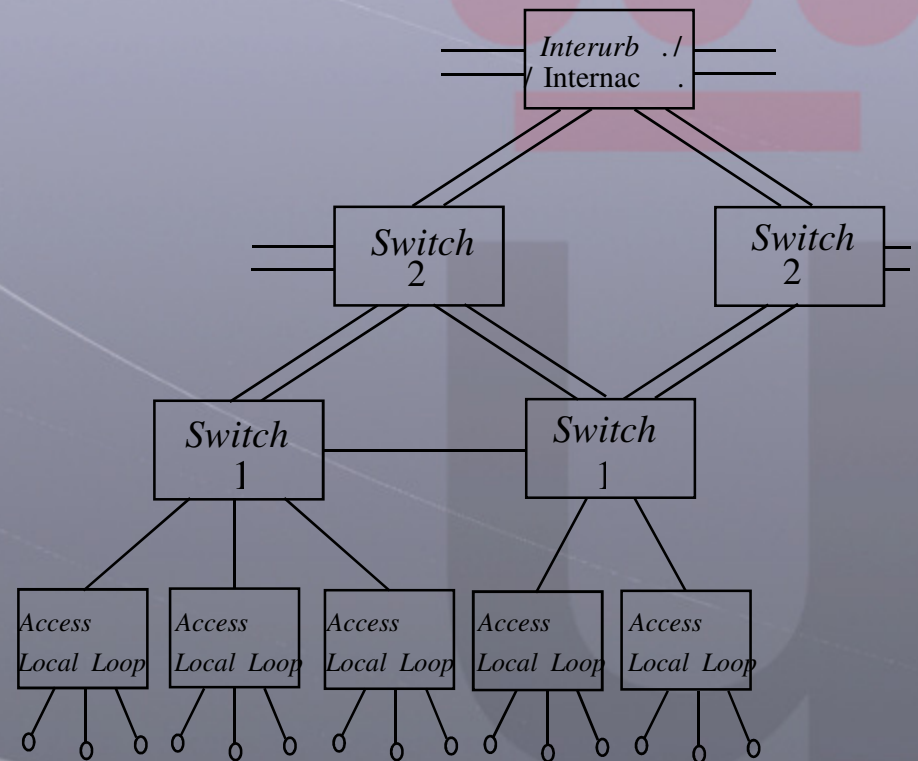

Simple Switching Network

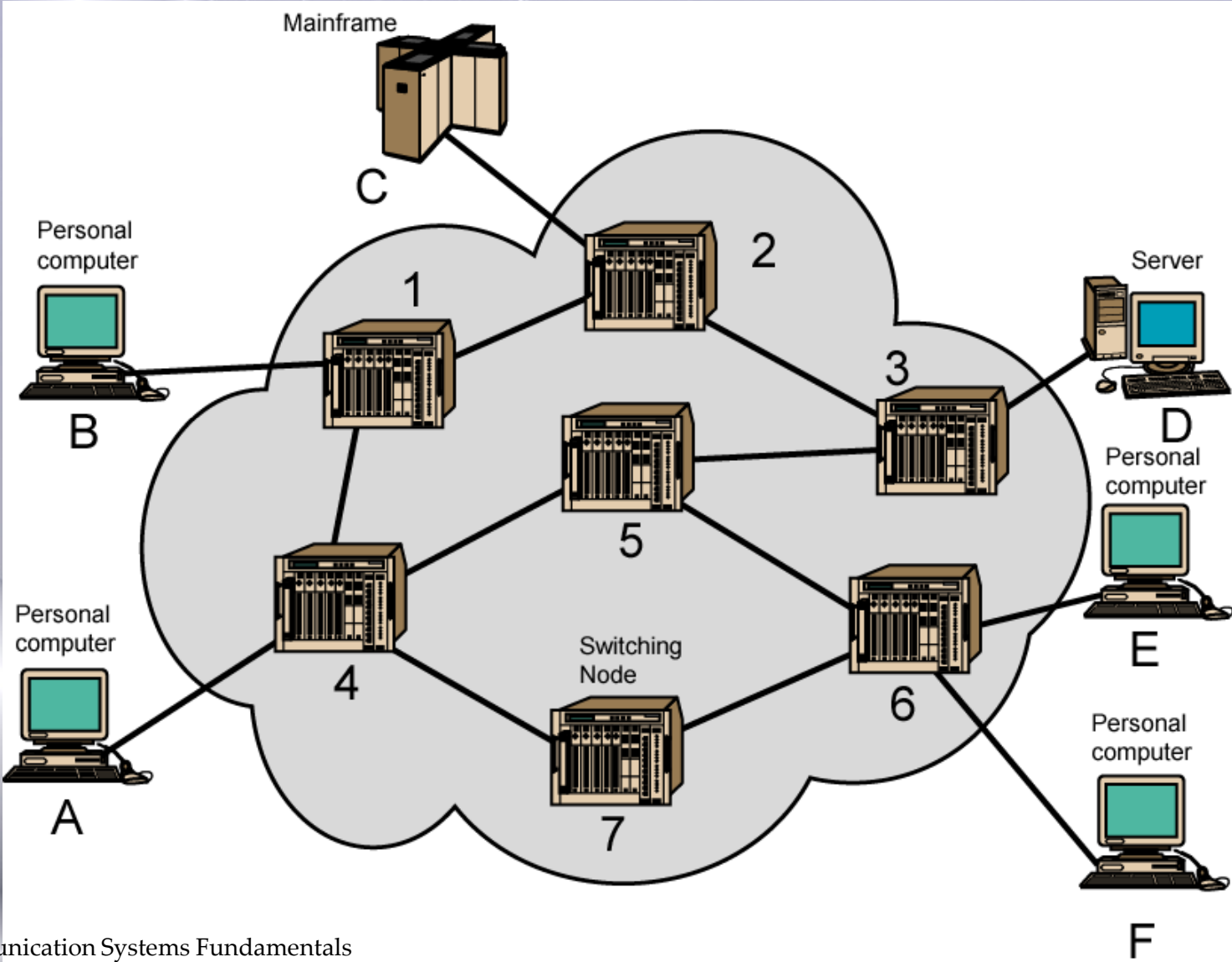

Switching Nodes

- Nodes may connect to other nodes, or to some stations.
- Network is usually partially connected
 - However, some redundant connections are desirable for reliability
- Two different switching technologies
 - Circuit switching
 - Packet switching

Circuit Switching

- Circuit switching:
 - There is a dedicated communication path between two subscribers (end-to-end)
 - The path is a connected sequence of links between network nodes. On each physical link, a logical channel is dedicated to the connection.
- Communication via circuit switching has three phases:
 - Circuit establishment (link by link)
 - Routing & resource allocation (FDM or TDM)
 - Data transfer
 - Circuit disconnect
 - Deallocate the dedicated resources
- The switches must know how to find the route to the destination and how to allocate bandwidth (channel) to establish a connection.

Circuit Switching Properties

- Inefficiency
 - Channel capacity is dedicated for the whole duration of a connection
 - If no data, capacity is wasted
- Delay
 - Long initial delay: circuit establishment takes time
 - Low data delay: after the circuit establishment, information is transmitted at a fixed data rate with no delay other than the propagation delay. The delay at each node is negligible.
- Developed for voice traffic (public telephone network) but can also applied to data traffic.
 - For voice connections, the resulting circuit will enjoy a high percentage of utilization because most of the time one party or the other is talking.
 - But how about data connections?

Public Circuit Switched Network

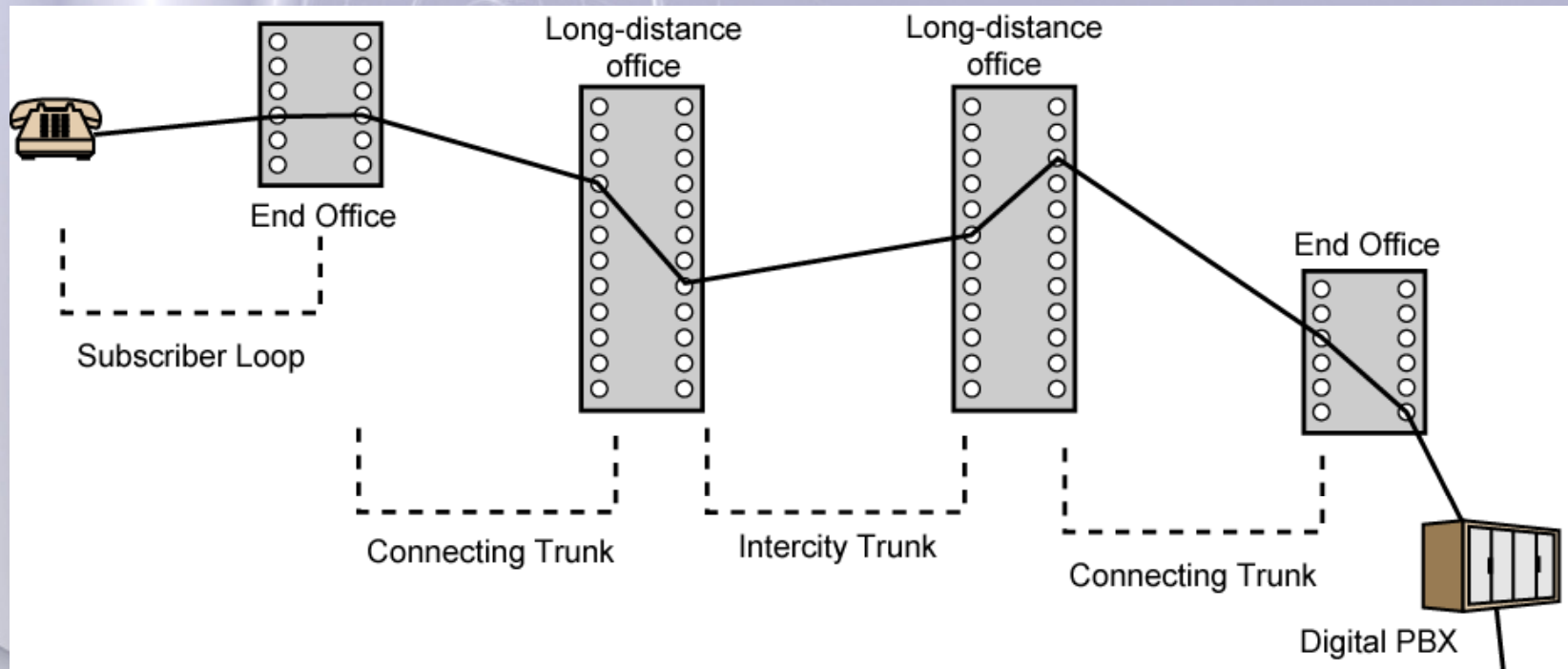

Subscribers: the devices that attach to the network.

Subscriber loop: the link between the subscriber and the network.

Exchanges: the switching centers in the network.

End office: the switching center that directly supports subscribers.

Trunks: the branches between exchanges. They carry multiple voice-frequency circuits using either FDM or synchronous TDM.

Packet Switching Principles

- Problem of circuit switching
 - Designed for voice service
 - Resources dedicated to a particular call
 - For data transmission, much of the time the connection is idle (say, web browsing)
 - Data rate is fixed
 - Both ends must operate at the same rate during the entire period of connection
- Packet switching is designed to address these problems

Basic Operation

- Data are transmitted in short **packets**
 - Typically at the order of 1000 bytes
 - Longer messages are split into series of packets
 - Each packet contains a portion of user data plus **some control info**
- Control info contains at least
 - Routing (addressing) info, so as to be routed to the intended destination
 - Recall the content of an IP header!
- **Store and Forward**
 - On each switching node, packets are received, stored briefly (buffered) and passed on to the next node.

Use of Packets

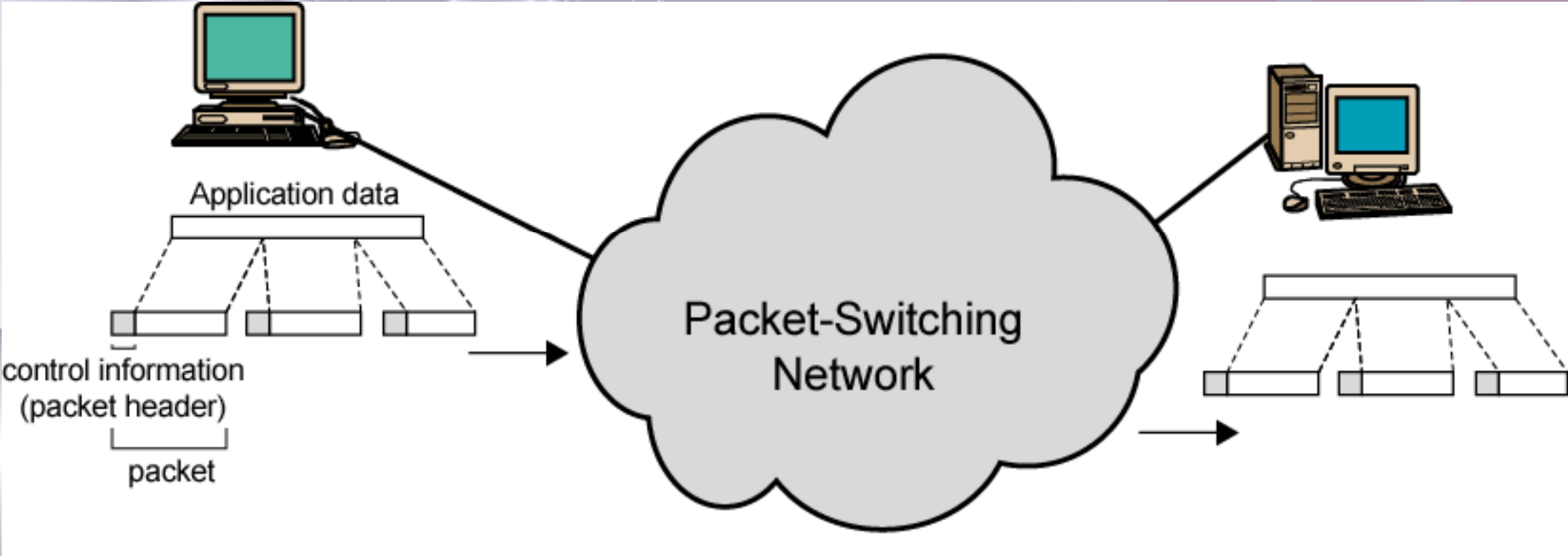

Advantages of Packet Switching

- Line efficiency
 - Single node-to-node link can be dynamically shared by many packets over time
 - Packets are queued up and transmitted as fast as possible
- Data rate conversion
 - Each station connects to the local node at its own speed
- In circuit-switching, a connection could be blocked if there lacks free resources. On a packet-switching network, even with heavy traffic, packets are still accepted, by delivery delay increases.
- Priorities can be used
 - On each node, packets with higher priority can be forwarded first. They will experience less delay than lower-priority packets.

Packet Switching Technique

- A station breaks long message into packets
- Packets are sent out to the network sequentially, one at a time
- How will the network handle this stream of packets as it attempts to route them through the network and deliver them to the intended destination?
 - Two approaches
 - **Datagram** approach
 - **Virtual circuit** approach

Datagram

- Each packet is treated independently, with no reference to packets that have gone before.
 - Each node chooses the next node on a packet's path
- Packets can take any possible route
- Packets may arrive at the receiver out of order
- Packets may go missing
- It is up to the receiver to re-order packets and recover from missing packets
- Example: **Internet**

Datagram

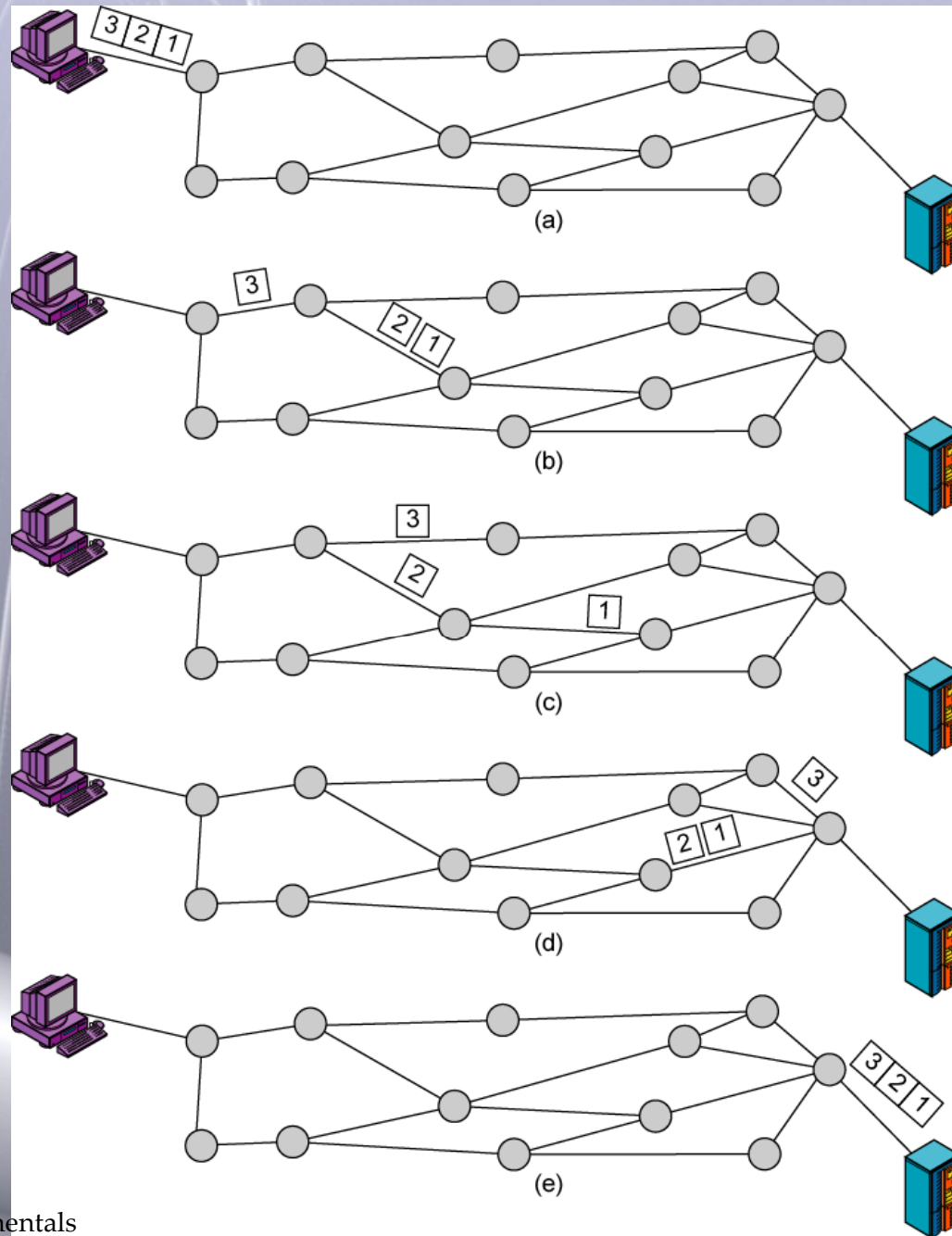

Virtual Circuit

- In virtual circuit, a preplanned route is established before any packets are sent, then all packets follow the same route
- Each packet contains a **virtual circuit identifier** instead of destination address, and each node on the preestablished route knows where to forward such packets
 - The node need not make a routing decision for each packet
- Example: X.25, Frame Relay, ATM

Virtual Circuit

A route between stations is set up prior to data transfer.

All the data packets then follow the same route.

But there is no dedicated resources reserved for the virtual circuit! Packets need to be stored-and-forwarded.

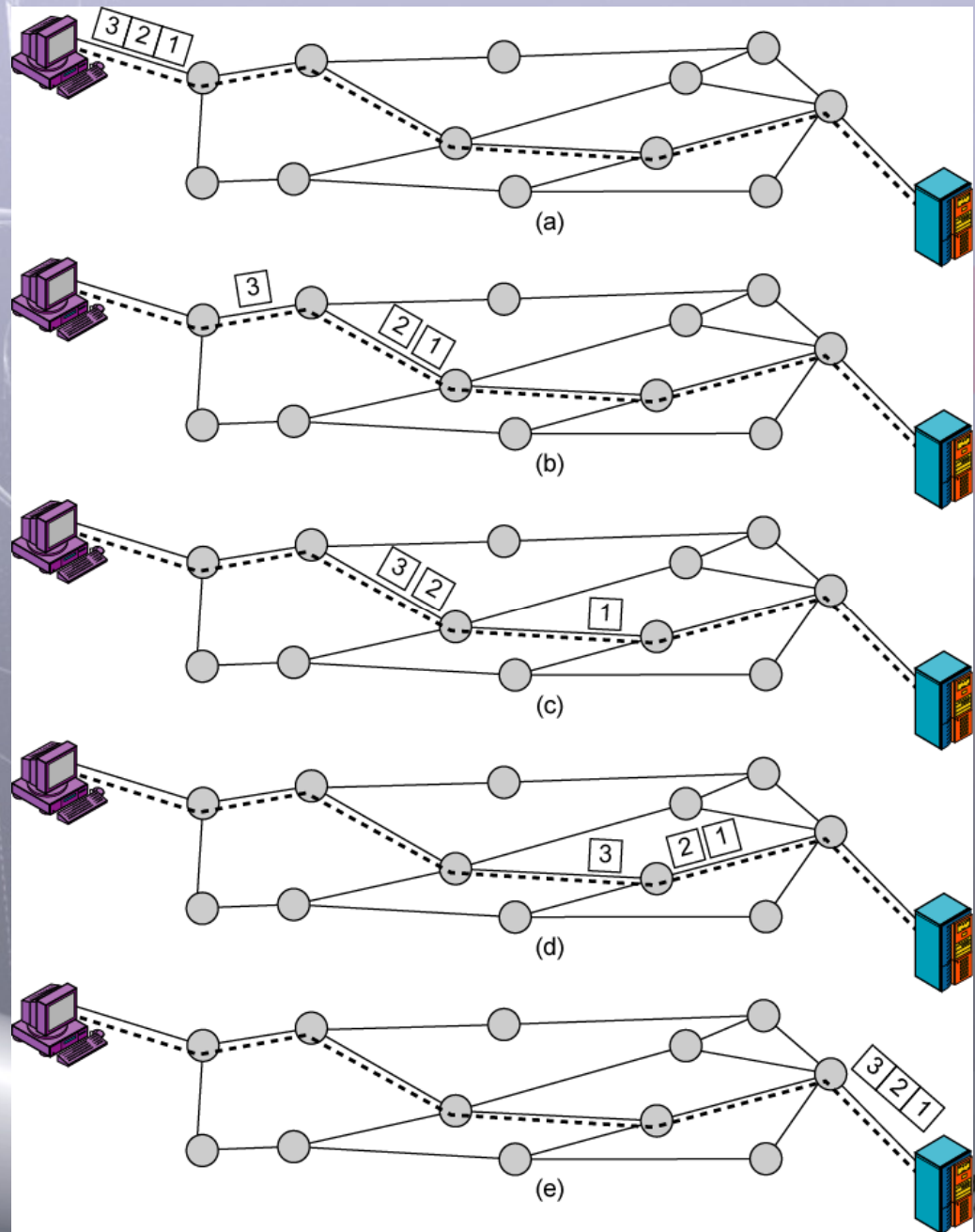

Virtual Circuits v Datagram

- Virtual circuits
 - Network can provide sequencing (packets arrive at the same order) and error control (retransmission between two nodes).
 - Packets are forwarded more quickly
 - Based on the virtual circuit identifier
 - No routing decisions to make
 - Less reliable
 - If a node fails, all virtual circuits that pass through that node fail
- Datagram
 - No call setup phase
 - Good for bursty data, such as Web applications
 - More flexible
 - If a node fails, packets may find an alternate route
 - Routing can be used to avoid congested parts of the network

Concepts in this Chapter

- *General Overview*
 - *Logarithmic Units (dB) and Link Budget*
 - *Review of fundamental parameters of physical layer: bandwidth, BER, SNR, Rate...*
 - *Other merit figures: Quality of Service*
 - *A/D Converter*
 - *Circuit Commutation vs. Packet Commutation*
 - *Network Topologies*
- *Functional Block Diagram of Analog Communications link*
- *Functional Block Diagram of a Digital Communications Link*
 - *Block description*
 - *Digital Modulations*
 - *Multiplexing and Multiple Access*

Theory classes: xx sessions (x hours)
Problems resolution: 1 session (2 hours)
Lab (Matlab): 2 hours

The Communication Process

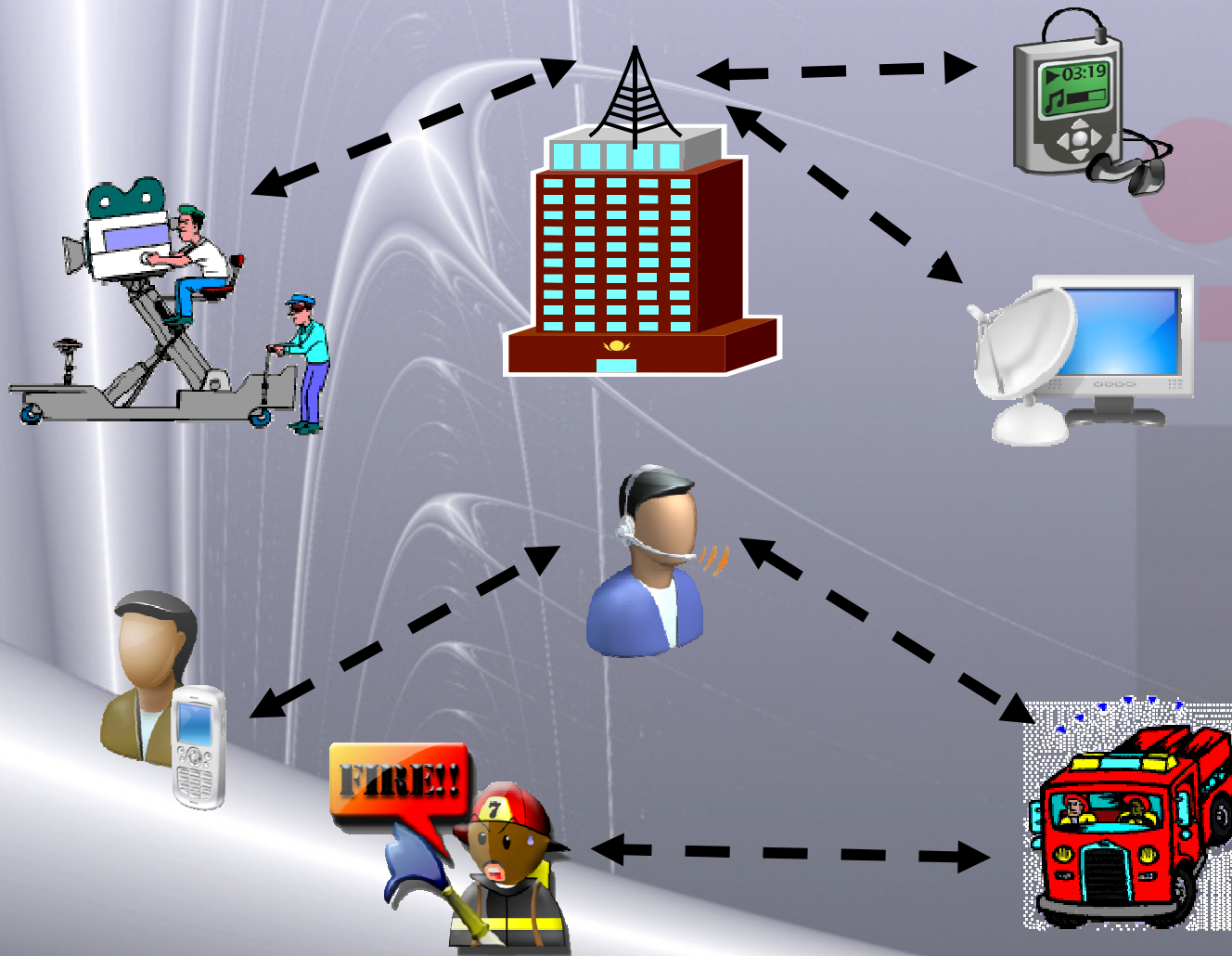

The Communication Process

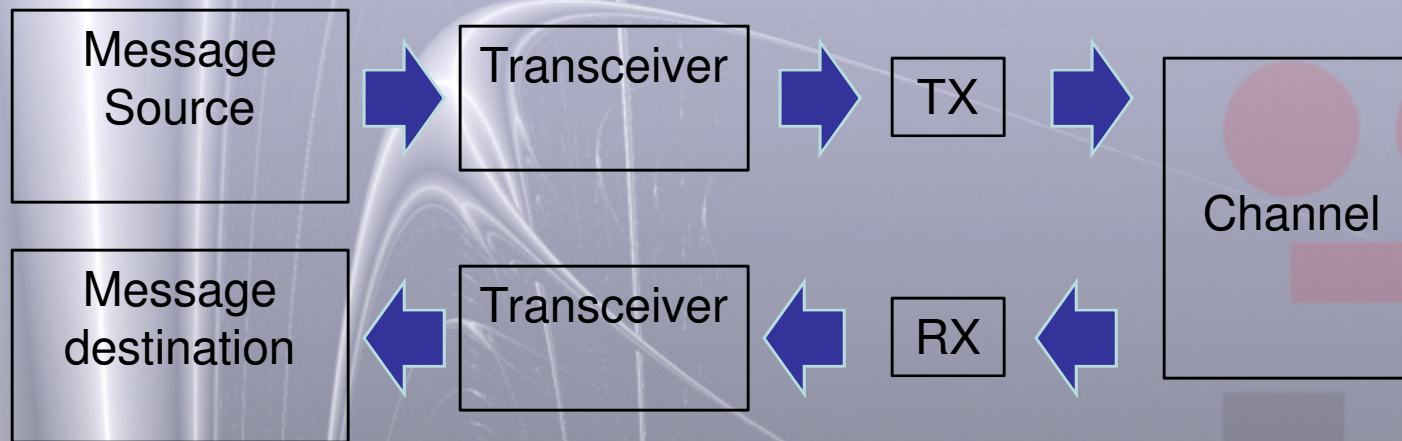

- **Input transceiver:** if the message is not an electromagnetic magnitude, it has to be converted into one of them: microphone, video camera, keyboard, etc.
- **Output transceiver:** if the message's destination is a human, the message has to be translated into a signal that can be perceived by human senses: sound, image, paper...

The Layers of Communication

- What are the system requirements?
 - It has to be fast
 - And ubiquitous (mobile)
 - Secure
 - Trustable (available)
 - Cheap
 - User-friendly
 - ...

How can we cope with all specifications?

The Layers of Communication

- How can we design such a system?

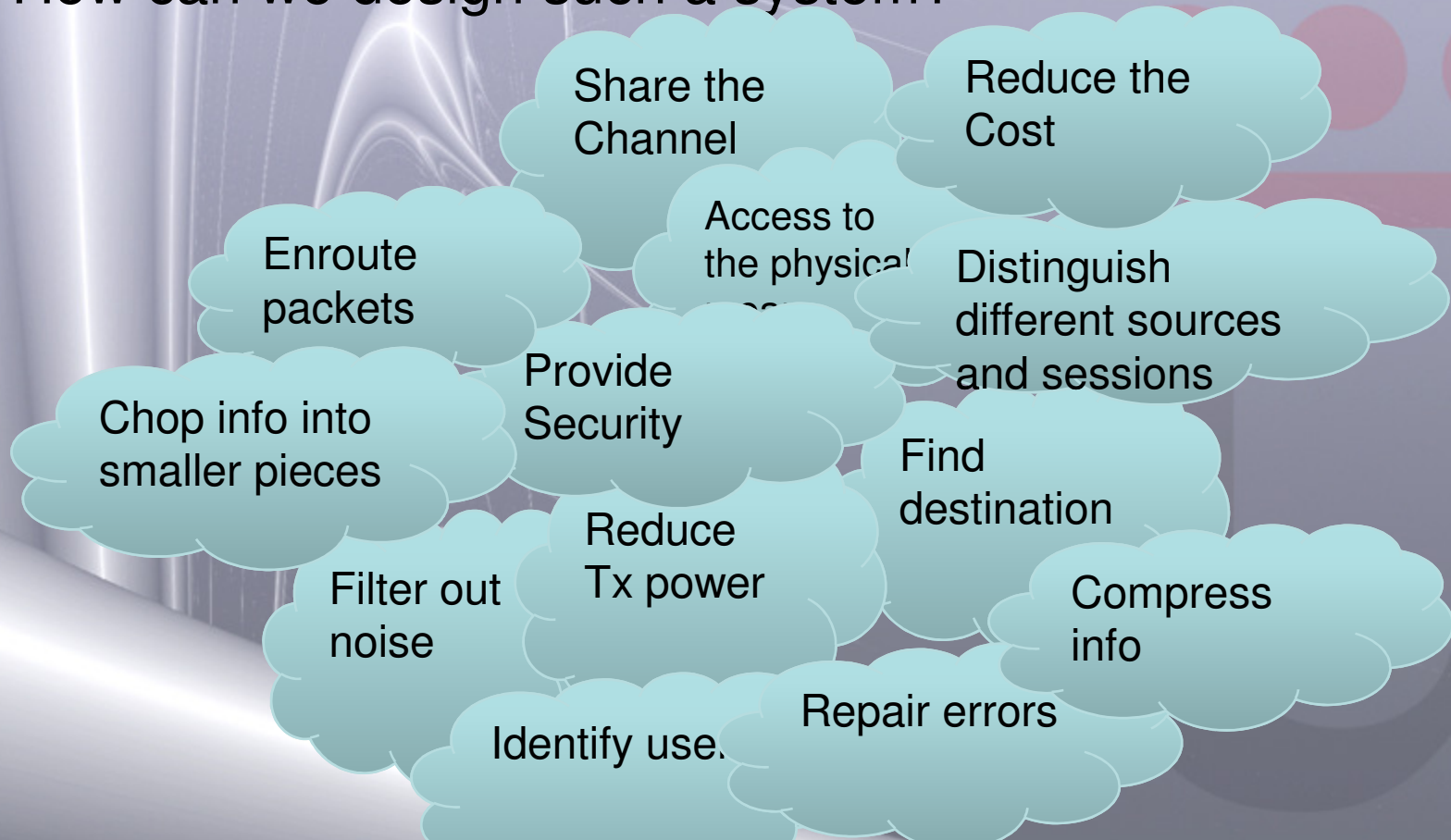

Systems are quite complex nowadays

The Layers of Communication: systems complexity



Preliminary Bill of Materials (BOM) Estimate for the 16Gbyte Version of the iPhone 4
(Costs in U.S. Dollars)*

Subsection	Part Description	Part Supplier/Part Details	Component Cost	
Applications Processor	Applications Processor	Samsung A4 APL0398 45nm, PoP	\$10.75	
	DRAM Memory	SDRAM, 4Gb Mobile DDR, PoP Samsung K4XK643GB (Samsung dies, 2 x 2Gb)	\$13.80	
	Misc. Applications Processor Components	Discretes, Passives, etc.	\$0.50	
Memory	Flash	Samsung NAND Flash 16GB MLC K9HDG08U5M-LCB0	\$27.00	
	Misc. Memory Components	Discretes, Passives, etc.	\$0.30	
Radio Frequency	Baseband	Infineon 337S3833	\$11.72	
	Transceiver	HSDPA/HSPA/WCDMA/EDGE Infineon 338S0626 Quad-Band GSM/Edge	\$2.33	
	Memory	Intel (Numonyx?) MCP 128Mb NOR Flash + 128Mb Mobile DDR (DDR is Elpida)	\$2.70	
	Power Mgmt.	n/a		
	PAM	Skyworks SKY77541-32 Transmit Module Quad-Band GSM/EDGE PAM + Antenna Switch	<included in Misc. Costs below>	
	PAM	Skyworks SKY77459-17 Transmit Module Single-Band WCDMA/HSPA PAM + Duplexer	<included in Misc. Costs below>	
	PAM	Skyworks SKY77452-20 Transmit Module Single-Band WCDMA/HSPA PAM + Duplexer	<included in Misc. Costs below>	
	PAM	TriQuint TQM676091 Transmit Module Single-Band WCDMA/HSPA PAM + Duplexer	<included in Misc. Costs below>	
	PAM	TriQuint TQM668092 Transmit Module Single-Band WCDMA/HSPA PAM + BAW Duplexer	<included in Misc. Costs below>	
	FEM	n/a		
	SAW Module	Murata	<included in Misc. Costs below>	
	Misc. RF Components	PAMs, Modules, Discretes, Passives, etc.	\$8.25	
	Power Management	Main PM Device	Dialog D1815A 338S0867-A4 Main Pwr Mgmt	\$2.03
		Misc. Power Mgmt.	Discretes, Passives, etc.	\$1.90
Connectivity	WiFi/BT	Broadcom BCM4329 Module WLAN 02.11a/b/g/n, Bluetooth V2.1+EDR, FM/RDS/RBDS Rcvr	\$7.80	
	GPS	Broadcom BCM4750	\$1.75	
	Misc. Connectivity Components	Discretes, Passives, etc.	\$0.80	
Interface & Sensors	Touchscreen Controller	Texas Instruments 343S0499 (F761586C)	\$1.23	
	Audio CODEC	Cirrus Logic 343S0589 (CL11495B0)	\$1.15	
	E-Compass	AKM AK8975 3-Axis	\$0.70	
	Accelerometer	ST Micro LIS331DLH 3-Axis	\$0.65	
	Gyroscope	ST Micro L3G4200D Digital 3-Axis	\$2.60	
	Misc. Interface & Sensor Components	Discretes, Passives, etc.	\$3.80	
Display/Camera	Display	3.5" Diag, LTPS LCD, 960x640 Pixels LG (or poss. TMD)	\$28.50	
	Touch Screen	Capacitive Glass, "Reinforced" Wintek or TPK/Balda	\$10.00	
	Camera	SMP Auto-Focus	\$9.75	
Battery	Camera (secondary)	VGA Auto-Focus	\$1.00	
	Battery	1400mAh	\$5.80	
Other	Mechanicals	Enclosure, Metals, Plastics, Hardware, etc.	\$10.80	
	Electro-Mechanicals	PCBs, Acoustics, Connectors, etc.	\$14.40	
	Misc.	Accessories, Literature, Box Contents	\$5.50	
TOTAL			\$187.51	

*Teardown costs account only for components and do not include other expenses such as manufacturing, software, royalties and licensing fees

The Layers of Communication

- Solution: ¡Divide et Impera!

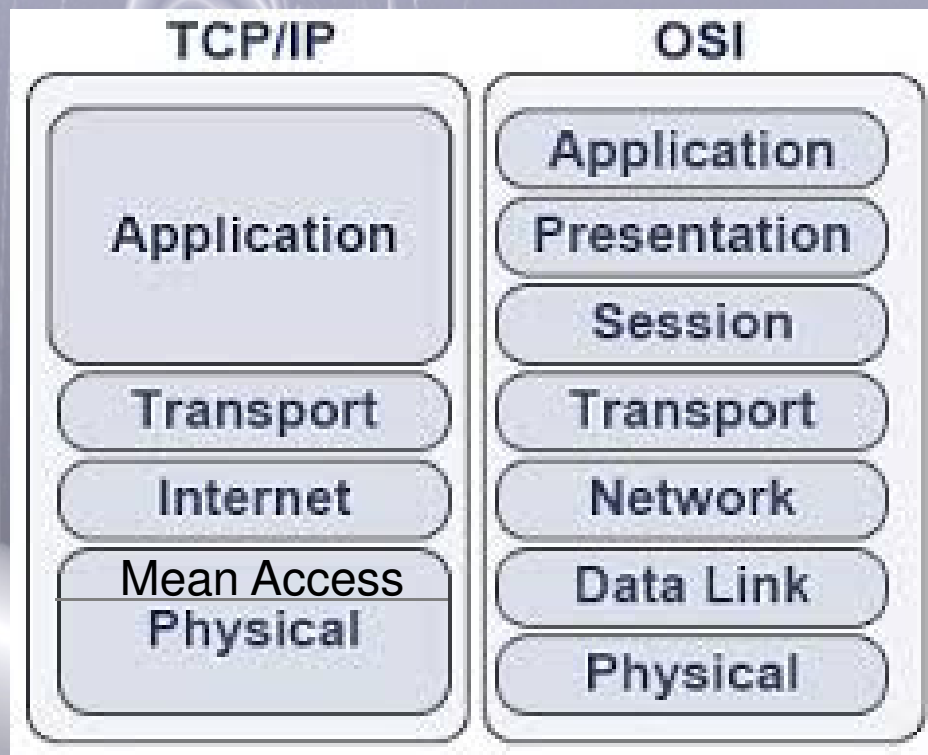

Functional Block Diagram of Analog Communications link

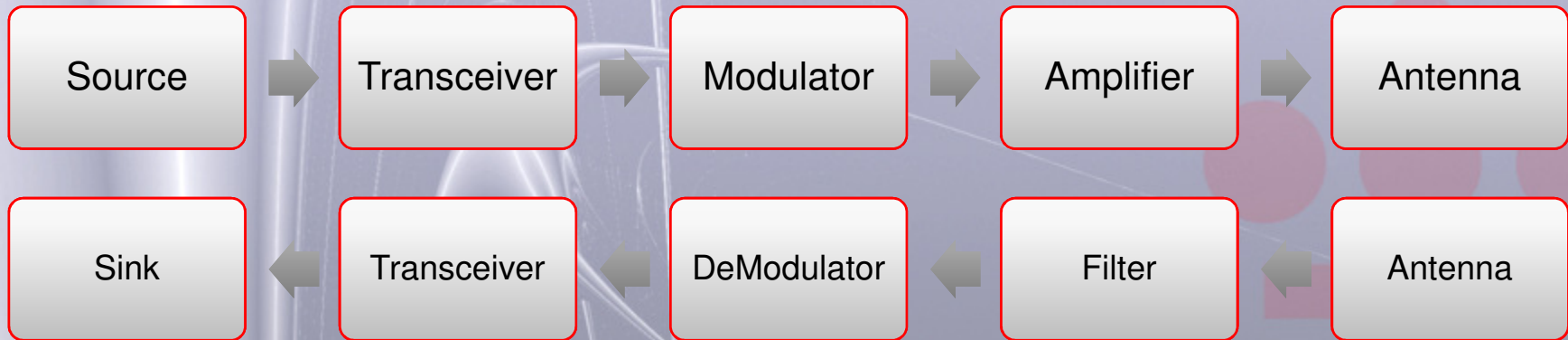

Example: VHF voice communication

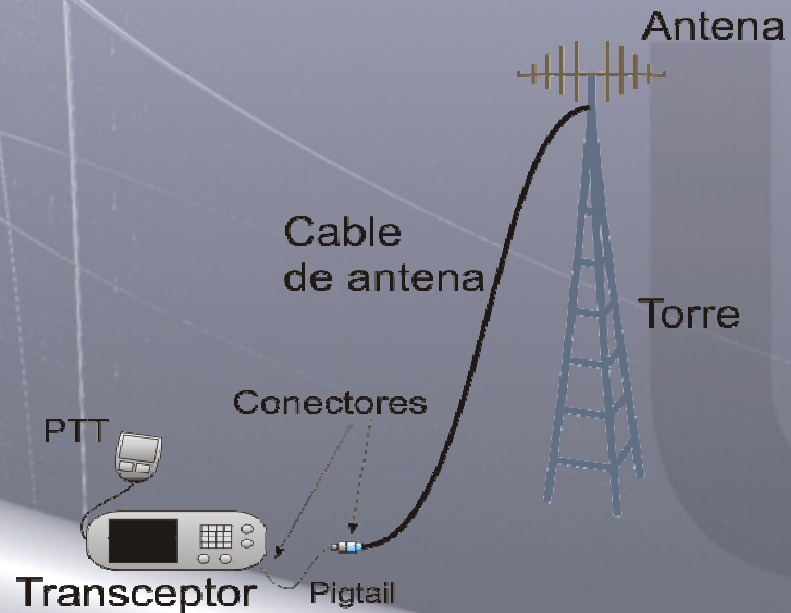

Example: VHF voice communication

- Source: voice. Bandwidth: 3 KHz (to understand it) and 21 KHz (for HiFi)
- Transceiver: microphone. Piezoelectric device that translates mechanical pressure into voltage
- Modulator: change the central frequency of the signal spectrum to be transmitted through an antenna

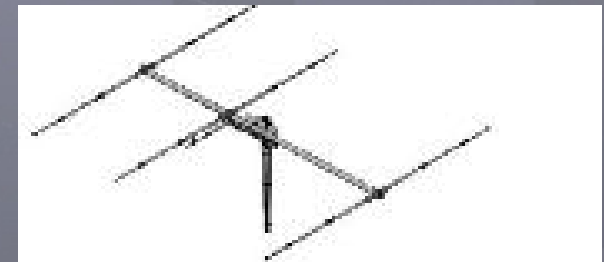
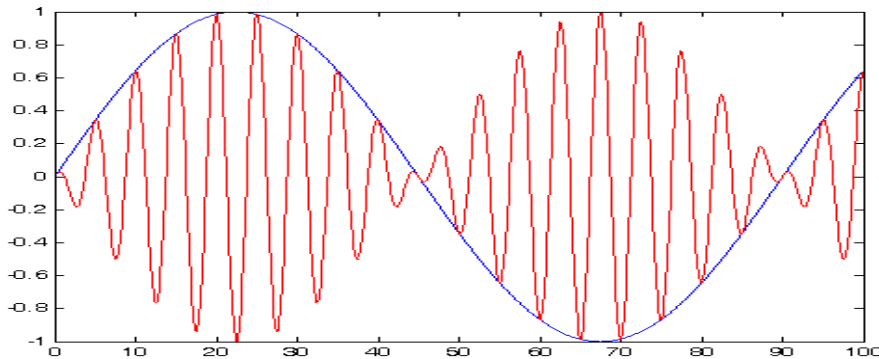
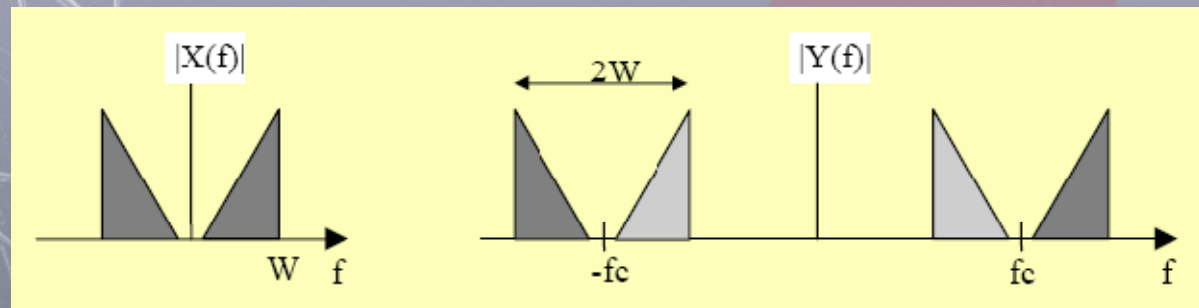
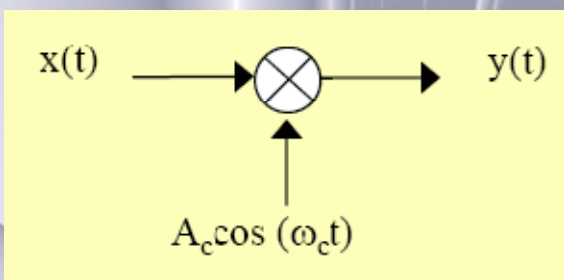

Example: VHF voice communication

- Antennas: the required antenna size is proportional to the wavelength. There are isotropic and directive antennas, the later provide a gain equivalent to the increase of the transmitted power

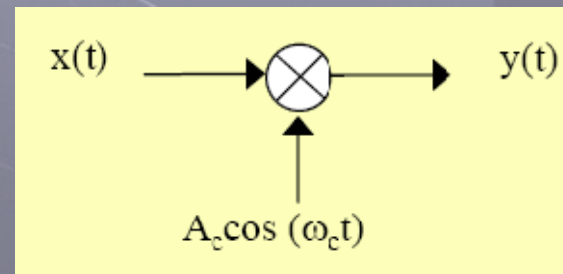
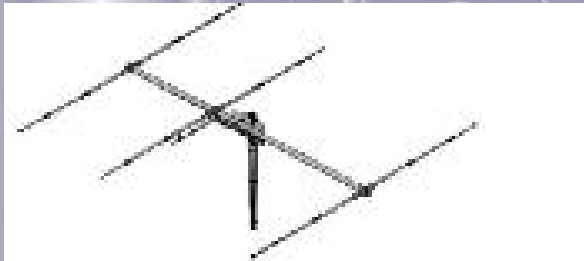

And from the Antenna to the Air

- The International Telecommunications Union (ITU), an organization from United Nations, provides recommendations for the spectrum usage
- Each country generates its own regulation for the spectrum usage according this recommendations guidelines
- Ex: 900 MHz → GSM.
- Wired communications regulation is less strict – there is not spectrum sharing conflicts

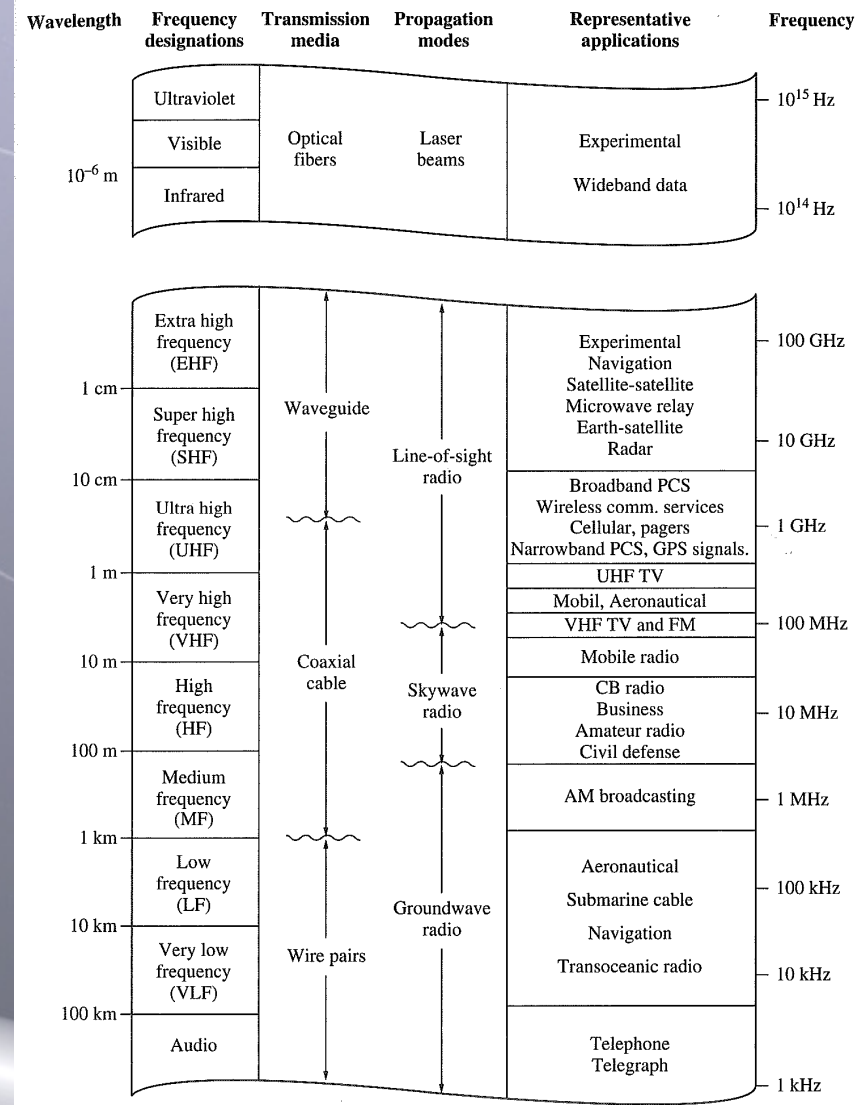

Modulation Concept

- Let a signal containing useful information (message signal), $m(t)$, which is assumed to be a lowpass signal of bandwidth W and non-zero power (time unlimited)

$$M(f) \equiv 0, \text{ for } |f| > W \quad (\text{note that } \omega = 2\pi f)$$

$$P_m = \lim_{T \rightarrow \infty} \frac{1}{T} \int_{-T/2}^{T/2} |m(t)|^2 dt$$

- Let a pure tone of frequency f_c , we will name carrier
 $c(t) = A_c \cos(2\pi f_c t + \varphi_c)$
- We say the message signal $m(t)$ modulates the carrier signal $c(t)$ in either amplitude, frequency, or phase, if after modulation, the amplitude, frequency, or phase of the signal $c(t)$ become functions of the message signal.

Modulation Concept

- Modulation converts the message signal $m(t)$ from *lowpass to bandpass, in the neighborhood of the center frequency f_c with the following objectives:*
 - The lowpass signal is translated in frequency to the passband of the channel so that the spectrum of the transmitted bandpass signal will match the passband characteristics of the channel;
 - To accommodate for simultaneous transmission of signals from several message sources, by means of frequency-division multiplexing
 - To expand the bandwidth of the transmitted signal in order to increase its noise immunity in transmission over a noisy channel

Modulation Types

- The physical parameters we can modify of the carrier signal are *amplitude*, la *frequency* y la *phase*:

$$c(t) = A \cos(2\pi ft + \phi)$$

- Depending on what parameter is modified

- | | | |
|------------------------------------|---|------------------------|
| - Amplitude Modulation (AM) | } | Linear modulations |
| - Frequency Modulation (FM) | | |
| - Phase Modulation (PM) | } | Non-Linear modulations |

Analogue vs Digital Modulations

- Within analogue modulations, the changing parameters of the carriers depends on the signal to be transmitted



- Within digital modulations, the carrier parameters is selected among a discrete number of possible values dependen on the sequence of bits to be transmitted

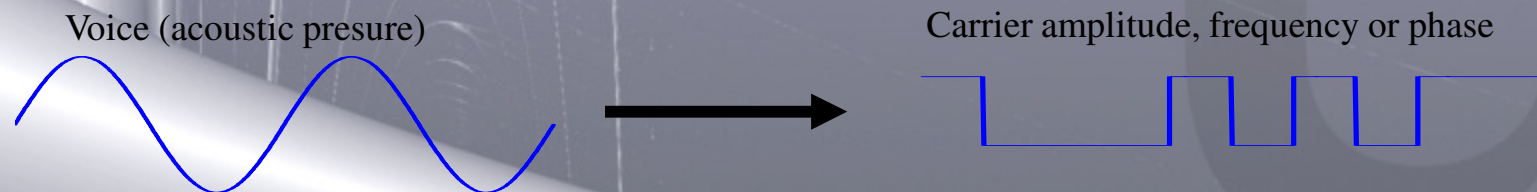

Linear Modulations

- Carrier amplitude, $c(t)$, is modified proportionally to the modulating signal, $m(t)$.

$$c(t) = A \cdot \cos(2\pi f_c t + \phi)$$

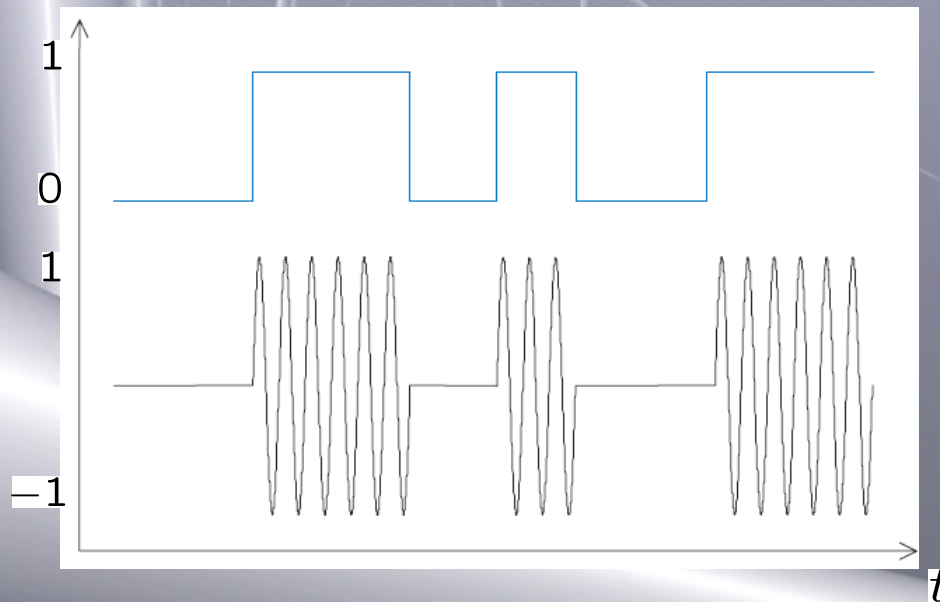

$m(t)$

$$x(t) = m(t) \cos(2\pi f_c t)$$

Linear Modulations

- Doble Side-Band
 - DSB-SC (*Double-Sideband Supressed Carrier*)
 - AM (*Conventional Amplitude Modulation*)

- Single Side-Band
 - SSB (*Single-Sideband*)
 - VSB (*Vestigial Sideband*)

Double-SideBand AM (DSB AM)

- Implementation of coherent receiver simplifies if a “carrier pilot” is added to de DSB-SC AM

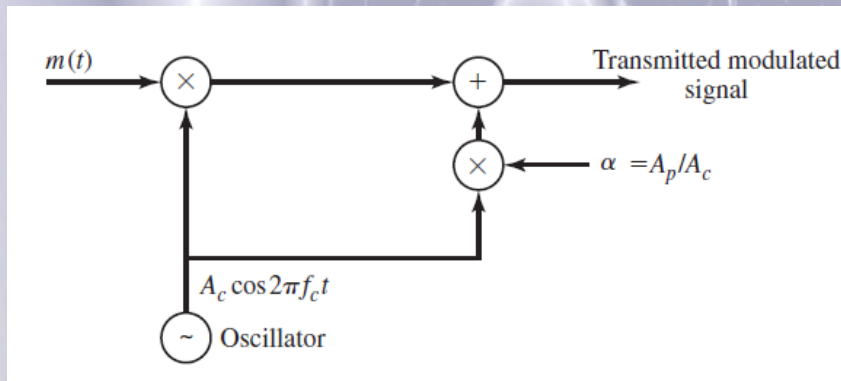

Tx

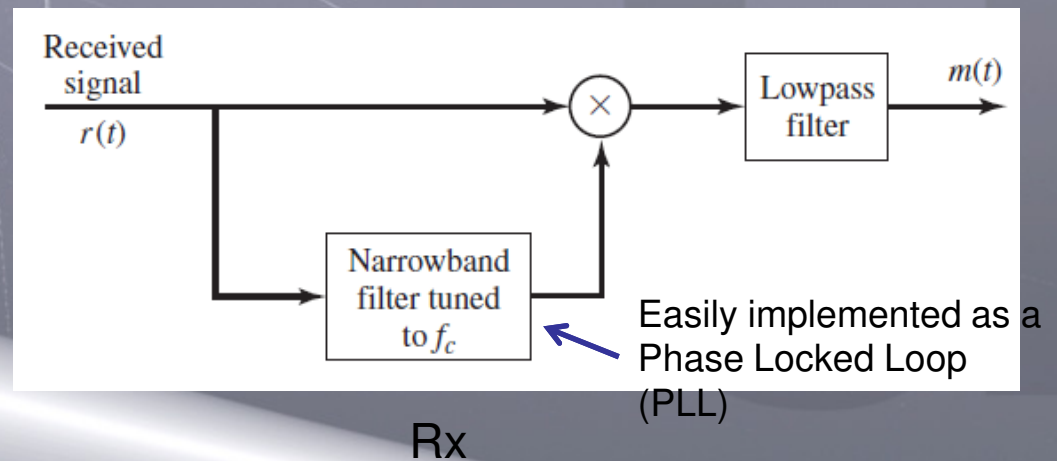

Rx

Double-SideBand AM (DSB AM)



$$c(t) = A \cos(2\pi f_0 t + \phi_0)$$

$$x(t) = m(t)A \cos(2\pi f_0 t + \phi_0)$$

$$m(t) = \sin(2\pi 100t)$$

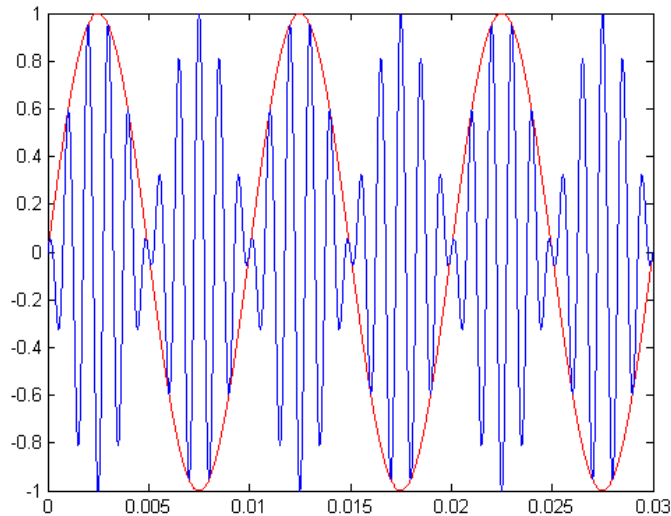

$$m(t) = 0.5 \sin(2\pi 100t) + 0.5$$

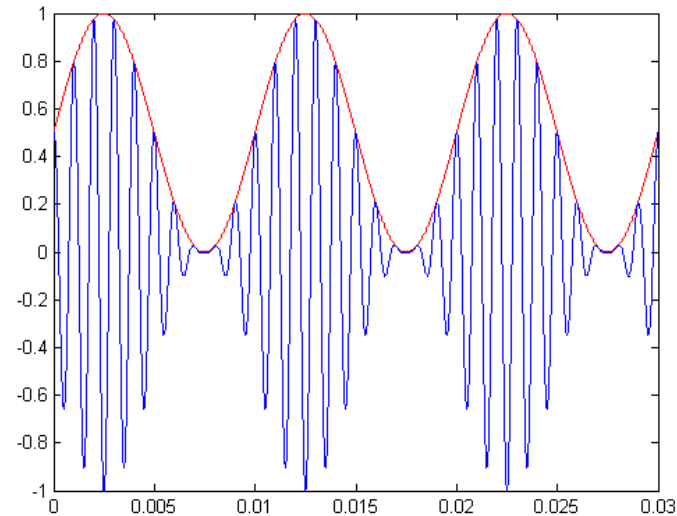

(Conventional) Amplitude Modulation

- Consists of a large carrier component in addition to the double-sideband AM modulated signal

$$u(t) = A_c [1 + am_n(t)] \cos 2\pi f_c t$$

being $m_n(t) = \frac{m(t)}{\max|m(t)|}$

and **a** ($0 < a < 1$) is called the **Modulation Index**

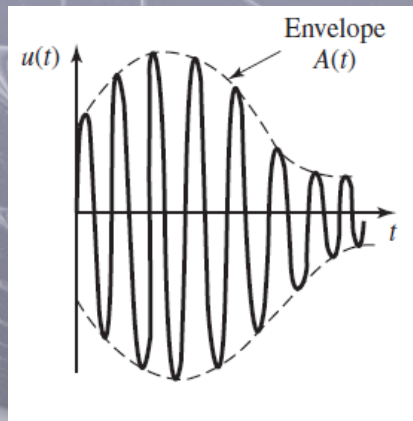

Single-SideBand Amplitude Modulation (SSB AM)

$$u(t) = A_c m(t) \cos 2\pi f_c t \mp A_c \hat{m}(t) \sin 2\pi f_c t$$

- where $\hat{m}(t)$ is the Hilbert transform of $m(t)$ which can be calculated as de convolution of $m(t)$ and a linear filter with impulse response $h(t) = 1/\pi t$, so its frequency response is

$$H(f) = \begin{cases} -j, & f > 0 \\ j, & f < 0 \\ 0, & f = 0 \end{cases}$$

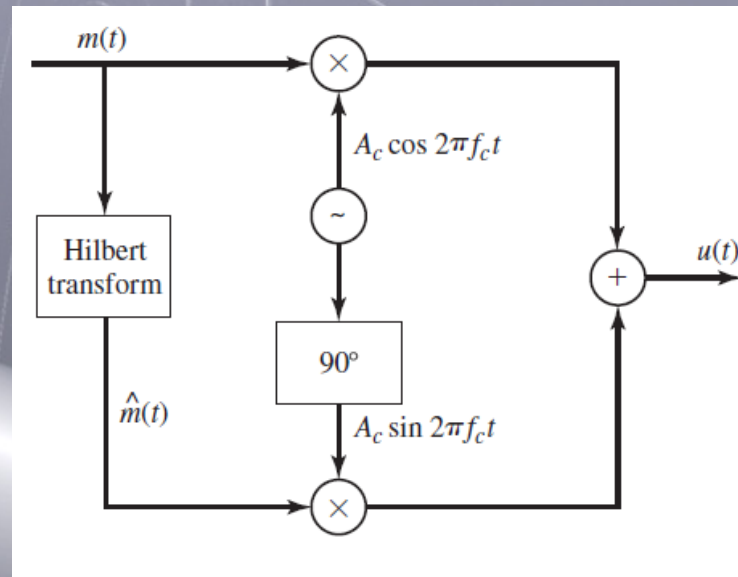

Angle Modulation

- Frequency-Modulation (FM) changes the frequency of the carrier, f_c , is changed by the message signal
- Phase-Modulation (PM) changes the phase of the carrier according to the variations in the message signal

$$u(t) = A_c \cos(2\pi f_c t + \phi(t))$$

– The instantaneous phase of this signal is $\phi(t)$

– The instantaneous frequency is

$$f_i(t) = \frac{1}{2\pi} \frac{d}{dt} \theta(t) = f_c + \frac{1}{2\pi} \frac{d}{dt} \phi(t)$$

• The phase in a PM is $\phi(t) = k_p m(t)$

• And the frequency in a FM is $f_i(t) - f_c = k_f m(t) = \frac{1}{2\pi} \frac{d}{dt} \phi(t)$

so consequently the phase is $\phi(t) = 2\pi k_f \int_{-\infty}^t m(\tau) d\tau$

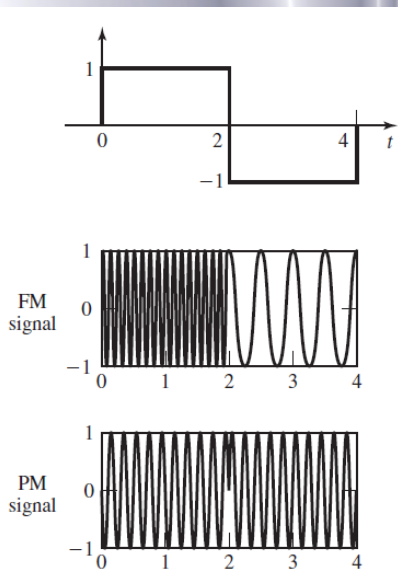

Angle Modulations

$$u(t) = A_c \cos(2\pi f_c t + \phi(t))$$

- Phase for PM is $\phi(t) = k_p m(t)$

- While for FM is $\phi(t) = 2\pi k_f \int_{-\infty}^t m(\tau) d\tau$

- For a general signal, $m(t)$, we define parameters

- β_p as “modulation index” of a PM modulation

$$\beta_p = k_p \max[|m(t)|]$$

- β_f as “modulation index” of a FM modulation

$$\beta_f = \frac{k_f \max[|m(t)|]}{W}$$

where W denotes the bandwidth of the message signal $m(t)$

- In terms of the maximum phase and frequency deviation ϕ_{\max} and f_{\max}

$$\beta_p = \Delta\phi_{\max}$$

$$\beta_f = \frac{\Delta f_{\max}}{W}$$

Summary of Analogue Modulations

Modul.	$\frac{B_w}{W}$	$\frac{SNR}{SNR_{BB}}$	Complexity
BB	1	1	Low
AM	2		Low
DSB	2	1	High
SSB	1	1	Moderate
VSB	1+	<1	Low
PM			Moderate
FM			Moderate

Concepts in this Chapter

- *General Overview*
 - *Logarithmic Units (dB) and Link Budget*
 - *Review of fundamental parameters of physical layer: bandwidth, BER, SNR, Rate...*
 - *Other merit figures: Quality of Service*
 - *A/D Converter*
 - *Circuit Commutation vs. Packet Commutation*
 - *Network Topologies*
- *Functional Block Diagram of Analog Communications link*
- *Functional Block Diagram of a Digital Communications Link*
 - *Block description*
 - *Digital Modulations*
 - *Multiplexing and Multiple Access*

Theory classes: xx sessions (x hours)
Problems resolution: 1 session (2 hours)
Lab (Matlab): 2 hours

Digital Communications Link

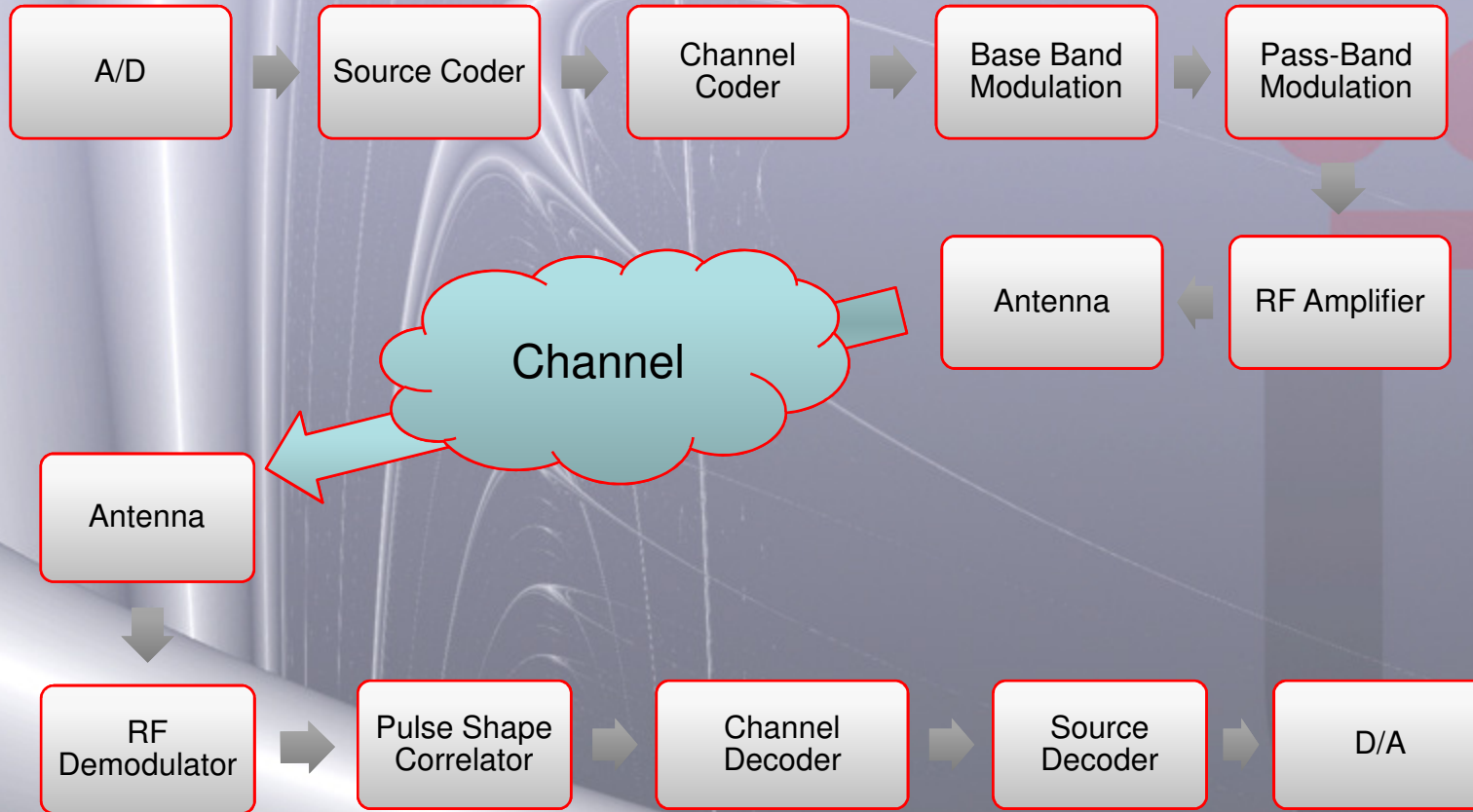

Analogue to Digital Converter

- Sampling
- Quantization
- Coding

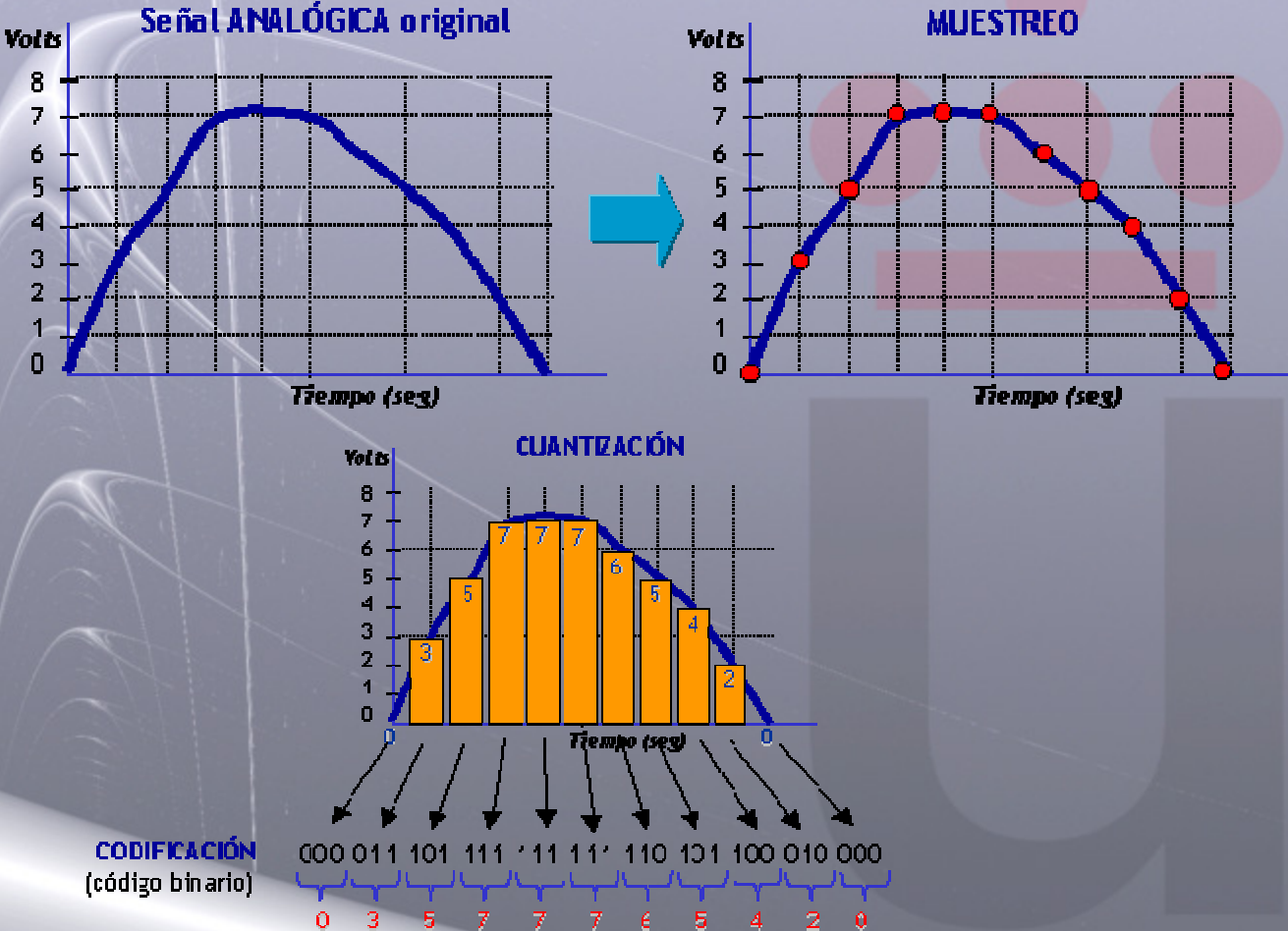

Digital to Analogue Converter

- At the other end – the Digital to Analogue Converter
 - Start with a bit stream
 - Groups the bits into packets (ex 8 bits provides 256 levels – standard for audio applications)
 - With the 8 bits a voltage level is generated holding it for a given time, T_{sampling}
 - Resulting signal is low-pass filtered

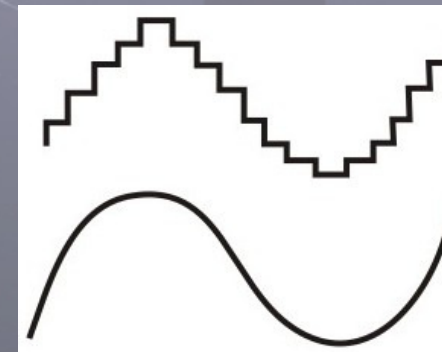
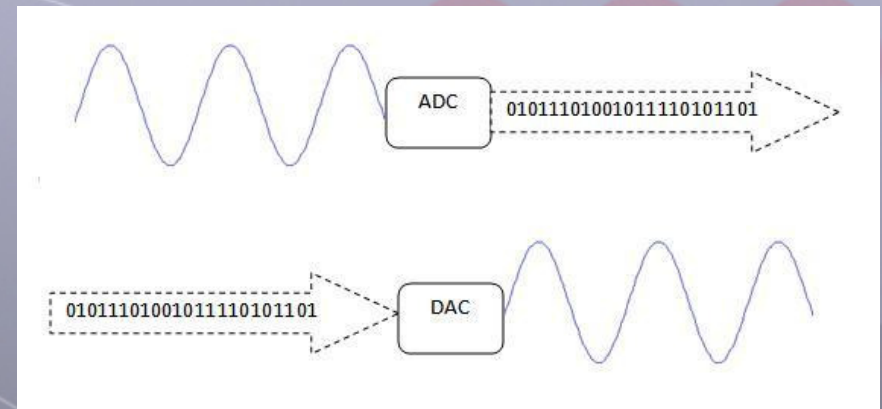

Source Coding

- The objective is to produce a bit sequence that represent (contain the same info) the message in the most effective way

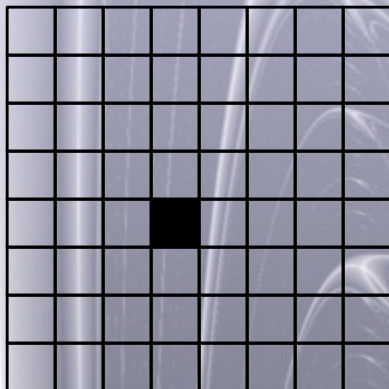

Image of 64 pixels with 16 gray levels:
 $64 \cdot 4 = 256$ bits.

In this particular picture, only on pixel is different from white: (row 4, column 5, level 16) $\rightarrow 3 + 3 + 4$ bits = 10 bits.

- Conclusion: any data has a minimum amount of information, named Entropy, and measured on “bits” units. The more efficient coder is, the number of used bits gets closer to the entropy

Source Coding

- Classic example: Morse code – letters coded with “dots” and “dashes”. The more frequent is a letter, the shorter is its code.
- Other considerations:
 - Real time (MPEG-2)
 - Simple decoding: MP-
 - Acceptable losses of info: JPEG
 - Cost of associated electronics

International Morse Code

1. A dash is equal to three dots.
2. The space between parts of the same letter is equal to one dot.
3. The space between two letters is equal to three dots.
4. The space between two words is equal to seven dots.

A	• —	U	• • —
B	— • • •	V	• • • —
C	— • — •	W	— — — •
D	— • • •	X	— • • • —
E	•	Y	— • — —
F	• • — •	Z	— — — • •
G	— — •		
H	• • • •		
I	• •		
J	• — — —		
K	— • — —		
L	• — • •		
M	— —		
N	— •		
O	— — —		
P	• — — •		
Q	— — • —		
R	• • • •		
S	• • •		
T	—		
		1	• — — — —
		2	• • — — —
		3	• • • — —
		4	• • • • —
		5	• • • • •
		6	— • • • •
		7	— — • • •
		8	— — — • •
		9	— — — — •
		0	— — — — —

Channel Coding

- Objectives:
 - To protect the Tx info against channel degradation
 - To add redundancy in an efficient way
 - To detect and correct errors caused by the channel
- Example: “dumb coder”. Whenever we want to transmit a “1”, the coder generates three “1s” – 111. The receiver gets the three symbols and makes a decision on what was transmitted. If it gets 101, what bit was transmitted?

Channel Coding

- Example: parity check bit

1 0 1 0 1 0 1 0	0
1 0 1 0 1 1 1 0	1
0 0 0 0 0 0 0 0	0
0 1 0 0 0 0 0 0	1
0 0 0 0 0 0 1 0	1
0 0 0 1 1 0 0 0	0

1 0 0 0 1 0 1 0	0
1 0 1 0 1 1 1 0	1
0 0 0 0 0 0 1 0	0
0 1 0 0 0 0 0 0	1
0 0 1 0 0 0 1 0	1
0 0 0 0 0 0 0 0 0	0

- The number of “1s” is to be even. It detects an odd number of errors. It wastes 11% of the channel capacity

Digital Modulation

- The modulator takes bits and generates signals with the right properties to make it through the channel
- The bit stream is grouped into k bits tuples
- For each of the $M = 2^k$ possible bit combination, modulator transmits a different signal $s_m(t)$ that lasts T_s seconds
- There is a biunivoque correspondence between each combination of M bits (symbol) and the signal transmitted

Digital Modulation

- Dummy example

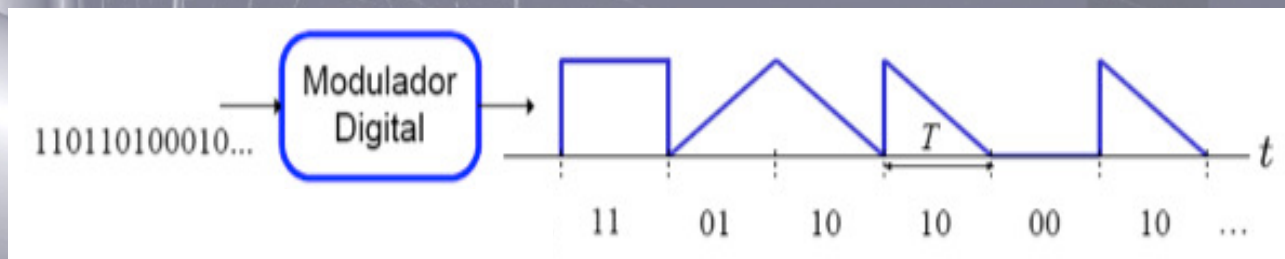
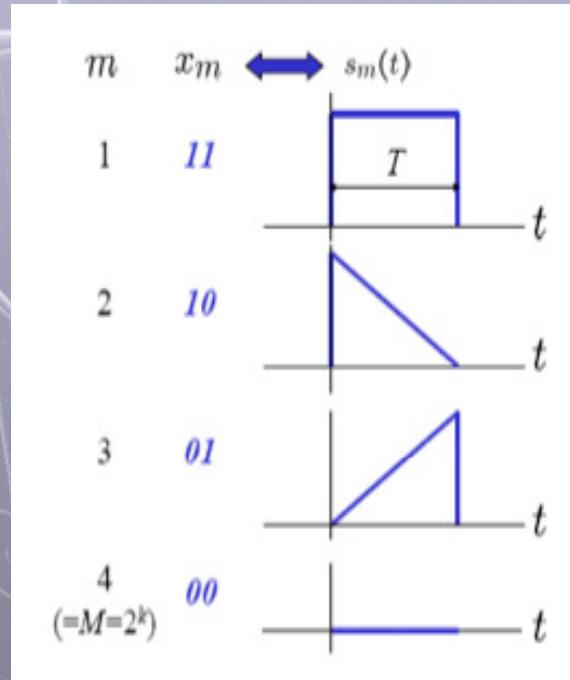

Detection and Estimation

- General model for digital transmission
 - Symbols are transmitted at a rate of $R = 1/T$ (a new symbol is transmitted every T seconds)

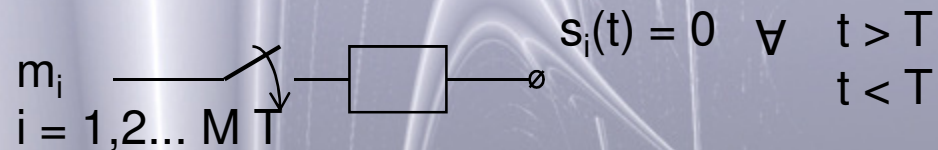

- Each symbol is transmitted as a different waveform
 - Let be a system with $M=4$ different symbols

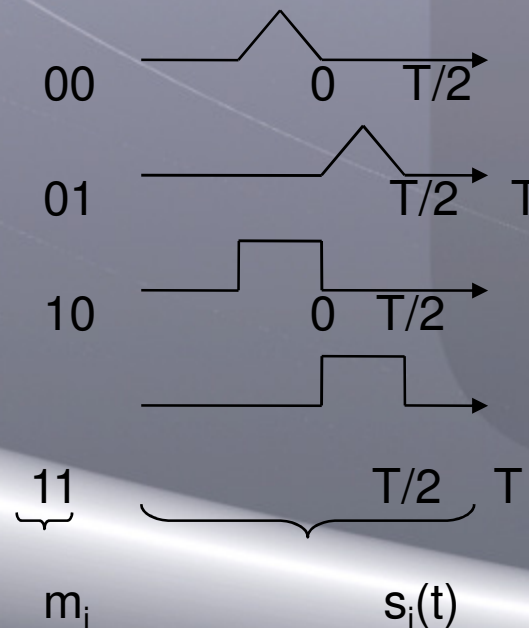

Properties of the transmitted Symbols, $S_i(t)$

- Limited Energy $E_x = \int_{-\infty}^{\infty} x^2(t) dt = \int_0^T x^2(t) dt < \infty$
- Energy Spectral Density (ESD) has to be confined in a bandwidth W
- In this case the Rx signal is
$$x(t) = S_i(t) + w(t)$$
 - where $w(t)$ is the noise (AWGN)
- The receiver is to estimate the transmitted symbol from the received signal

$$x(t) \Rightarrow \hat{m}_i$$

Geometric Interpretation

- Given a set of M signals $s_i(t)$,

$$s_i(t) = \sum_{j=1}^N s_{ij} \Phi_j(t) \quad s_{ij} = \int_0^T s_i(t) \Phi_j(t) dt = \langle \Phi_j(t), s_i(t) \rangle$$

- Each of them can be interpreted as a vector

$$s_i(t) \Rightarrow \bar{s}_i = \begin{bmatrix} s_{i1} \\ s_{i2} \\ \vdots \\ s_{iN} \end{bmatrix}$$

- Of the N-dimensional Euclidean Space $\Phi_j(t) \quad j=1..N$
 - Where the energy of $s_i(t)$ can be calculated as

$$E_i = \int_0^T s_i^2(t) dt = \int_0^T \left[\sum_{j=1}^N s_{ij} \Phi_j(t) \sum_{k=1}^N s_{ik} \Phi_k(t) \right] dt$$

$$= \sum_j \sum_k s_{ij} s_{ik} \int_0^T \Phi_j(t) \Phi_k(t) dt = \sum_j \sum_k s_{ij} s_{ik} \delta_{jk} = \sum_{j=1}^N s_{ij}^2$$

$$E_i = \sum_{j=1}^N s_{ij}^2 = |\bar{s}_i|^2$$

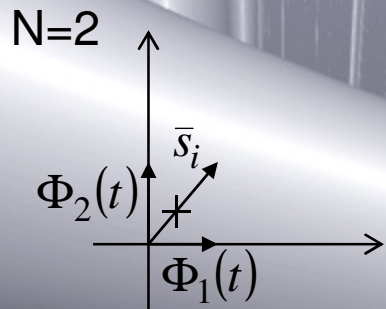

Optimum Receiver using Correlators

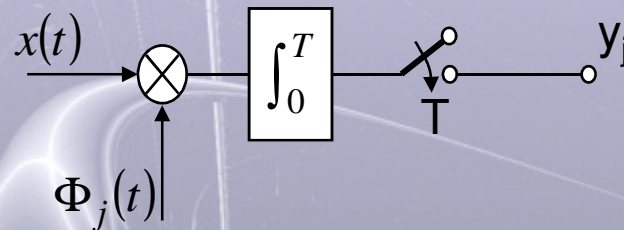

$$y_j = \int_0^T x(t) \Phi_j(t) dt$$

$$x(t) = s_i(t) + w(t)$$

- Received signal can be modeled as $i = 1, \dots, M$

$$w(t) \equiv \text{AWGN of PSD } N_0/2$$

- Correlation during interval $[0, T]$ between $x(t)$ y $\Phi_j(t)$ is computed, resulting

$$y_j = \int_0^T x(t) \Phi_j(t) dt = \underbrace{\int_0^T s_i(t) \Phi_j(t) dt}_{=S_{ij}} + \underbrace{\int_0^T w(t) \Phi_j(t) dt}_{\text{Gaussian Random Variable}}$$

$=S_{ij}$

Gaussian Random Variable

{ - mean
- variance

Optimum Receiver with a Bank of Correlators

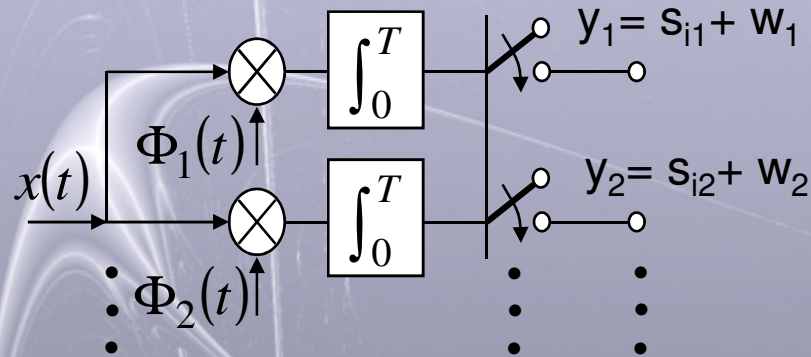

$$\begin{aligned}
 \text{Cov}[y_j, y_k] &= E[(y_j - s_{ij})(y_k - s_{ik})] = E\left[\int_0^T w(t) \Phi_j(t) dt, \int_0^T w(u) \Phi_k(u) du\right] = \\
 &= \int_0^T \int_0^T E[w(t)w(u)] \Phi_j(t) \Phi_k(u) dt du = \int_0^T \int_0^T \frac{N_0}{2} \delta(t-u) \Phi_j(t) \Phi_k(u) dt du = \\
 &= \frac{N_0}{2} \int_0^T \Phi_j(t) \Phi_k(t) dt = \delta_{jk} \frac{N_0}{2}
 \end{aligned}$$

$$\left\{ \begin{array}{l} \text{Cov}(y_j, y_k) = 0 \iff y_j, y_k \text{ are uncorrelated} \\ \text{Two uncorrelated and Gaussiand RV are Independet} \end{array} \right. \quad \left\{ \begin{array}{l} E[y_j] = s_{ij} \\ \text{Cov}[y_j, y_k] = \frac{N_0}{2} \delta_{ik} \end{array} \right.$$

Optimum Detection

- Decision Zone for symbol i
 - Locus of points which distance to point s_i is smaller than to any other point of the constellation

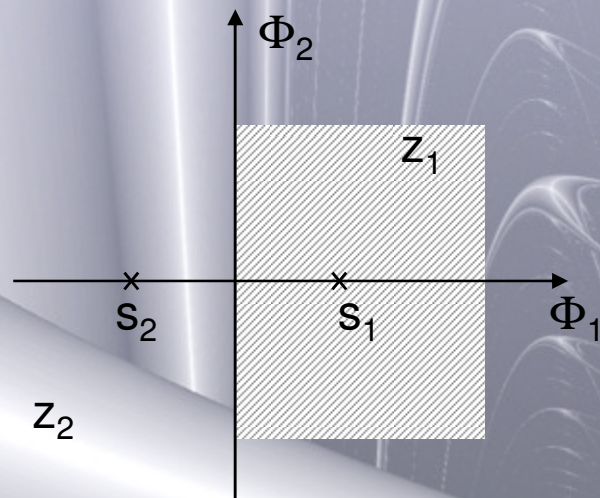

$$\hat{m} = \min_{m_i} |\bar{y} - \bar{s}_i|^2 = \min_{m_i} \left[\sum_{j=1}^N y_j^2 - \sum_{j=1}^N 2y_j s_{ij} + \sum_{j=1}^N s_{ij}^2 \right] =$$

$$= \min_{m_i} \left[- \sum_{j=1}^N 2y_j s_{ij} + E_i \right] = \max_{m_{in}} \left[\sum_{j=1}^N y_j s_{ij} - \frac{1}{2} E_i \right]$$

Error Probability and Optimum Detection

- Defining a new orthonormal basis which axis passes through both points

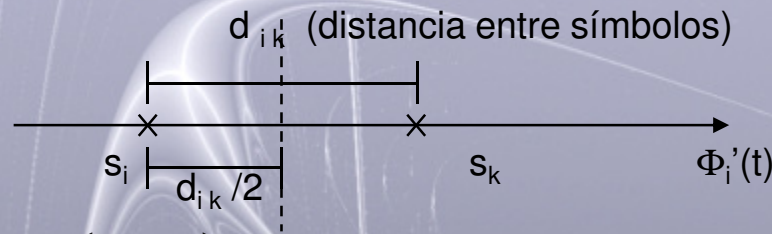

$$\operatorname{erfc}(x) = \int_x^{\infty} \frac{2}{\sqrt{\pi}} e^{-u^2} du$$

$$Q(z) \equiv \frac{1}{\sqrt{2\pi}} \int_z^{\infty} e^{-\frac{x^2}{2}} dx$$

$$Q(z) = \frac{1}{2} \operatorname{erfc}\left(\frac{z}{\sqrt{2}}\right)$$

$$\operatorname{erfc}(z) = 2 Q(\sqrt{2} z)$$

$$f_{y'}(y' / m_i) = \text{Gaussian}\left(s_i, \frac{N_0}{2}\right)$$

$$P(\bar{A}_{ik}) = P(m_k / m_i) = \int_{d_{ik}/2}^{\infty} \frac{1}{\sqrt{\pi N_0}} e^{-\frac{(y')^2}{N_0}} = \frac{1}{2} \operatorname{erfc}\left(\frac{1}{2} \frac{d_{ik}}{\sqrt{N_0}}\right)$$

- and applying the Union Upper Bound, the error probability of m_i symbol becomes

$$Pe(m_i) = \frac{1}{2} \sum_{\substack{k=i \\ k \neq i}}^M \operatorname{erfc}\left(\frac{1}{2} \frac{d_{ik}}{\sqrt{N_0}}\right)$$

- Thus, the system total probability of error

$$Pe = \frac{1}{M} \sum_{i=1}^M \frac{1}{2} \sum_{\substack{k=i \\ k \neq i}}^M \operatorname{erfc}\left(\frac{1}{2} \frac{d_{ik}}{\sqrt{N_0}}\right)$$

Error Probability and Optimum Detection

- Defining again the minimum distance as

$$d_{min} = \min_{\substack{i,k \\ i \neq k}} d_{ik}$$

- and using the inequality

$$\sum_{\substack{k=1 \\ i \neq k}}^M \operatorname{erfc}\left(\frac{d_{ik}}{2\sqrt{N_0}}\right) \leq (M-1) \operatorname{erfc}\left(\frac{d_{min}}{2\sqrt{N_0}}\right)$$

- The Union Upper Bound for the Symbol Error Probability results as

$$Pe \leq \frac{(M-1)}{2} \operatorname{erfc}\left(\frac{d_{min}}{2\sqrt{N_0}}\right)$$

Optimum Detector

- It can be proof that both approaches, correlator and matched filter, are mathematically equivalent

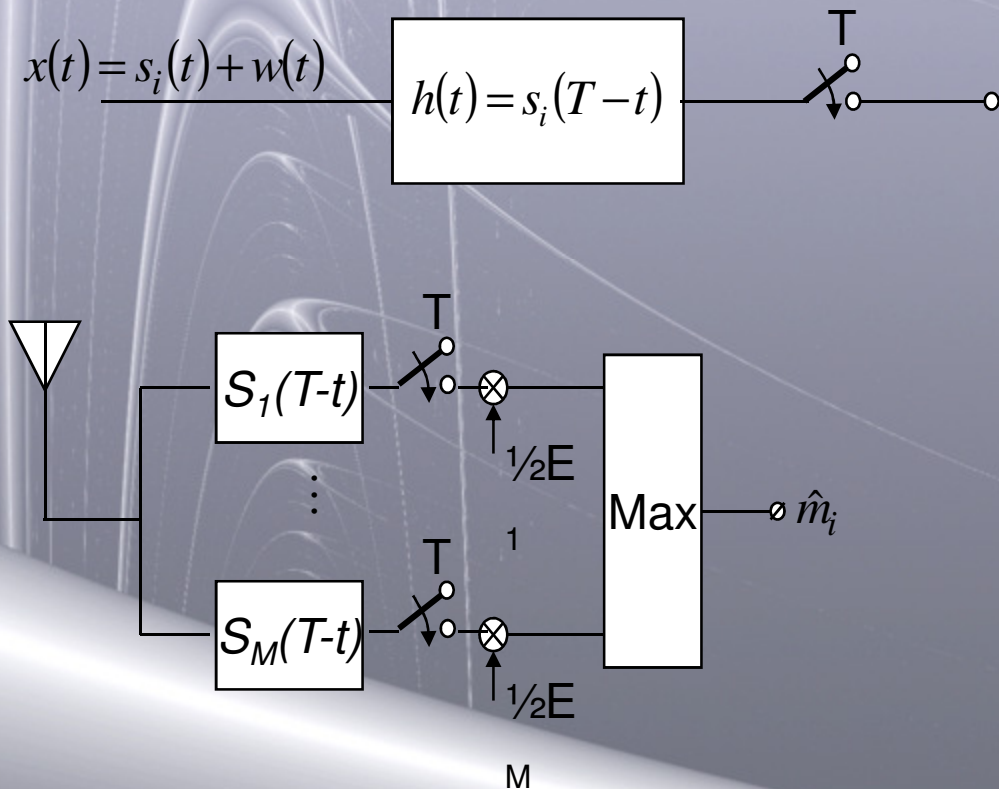

Base-Band Transmission

- Some systems require transmitted signal to have its spectrum around DC frequency – Base-Band Transmission



$$H_{s_i} = |TF[S_i(t)]|^2$$

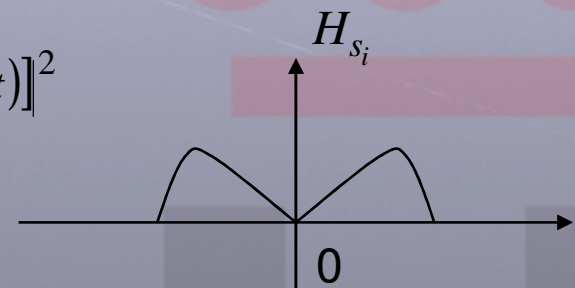

- General denomination for the most common modulations in base-band: PAM (Pulse Amplitude Modulation)

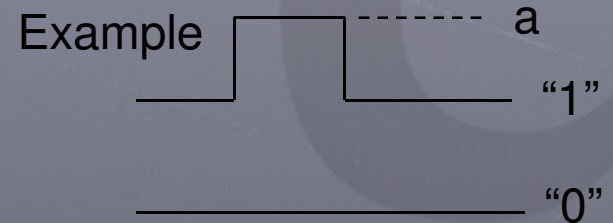
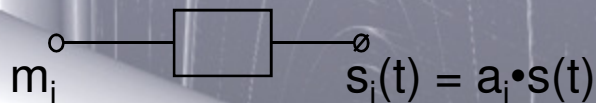

PAM

- Signal types depending on the pulse shape, $s(t)$

- NRZ (Non Return to Zero)

$$\left\{ \begin{array}{l} s(t) \neq 0 \quad 0 \leq t \leq T \end{array} \right.$$

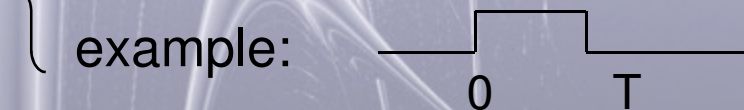

- Manchester or Bi-Phase

$$\left\{ \begin{array}{l} s(t) = -s(t+T/2) \quad 0 \leq t \leq T \end{array} \right.$$

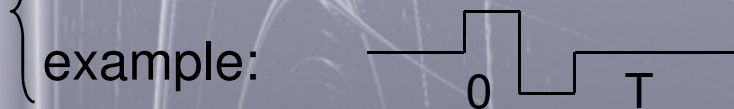

- RZ (Return to Zero)

$$\left\{ \begin{array}{l} s(t) = 0 \quad t_i \leq t \leq T \end{array} \right.$$



PAM

- Signal types depending on the amplitudes, a_i

- Unipolar $a_i \geq 0 \quad \forall i$

Examples: Binary Unipolar NRZ

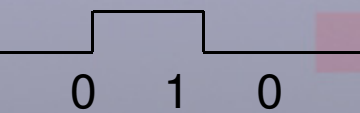
$$a_i = \begin{cases} 1 & \text{si } m_1 \\ 0 & \text{si } m_0 \end{cases}$$

Binary Unipolar NRZ

$$a_i = \begin{cases} 1 & \text{si } m_1 \\ 5 & \text{si } m_0 \end{cases}$$

- Polar $a_i = -a_i + M/2$

Binary polar NRZ

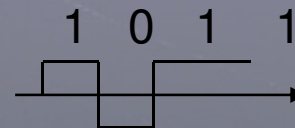

Quaternary Polar NRZ

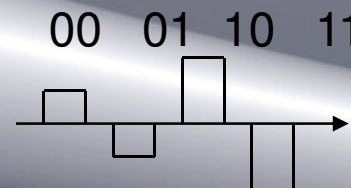

PAM

- Signal types depending on the amplitudes, a_i (cont.)

- Bipolar

$$a_i = \begin{cases} 0 & \text{if } m_0 \\ -a_1 & \text{if } m_1 \end{cases}, a_1 \equiv \text{last } m_1 \text{ Tx}$$

Example: Binary Bipolar NRZ

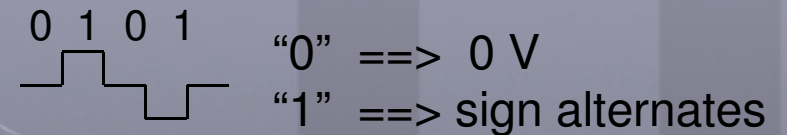

- Differential

$$a_i = \begin{cases} a_{i-1} & \text{if } m_0 \\ -a_{i-1} & \text{if } m_1 \end{cases}$$

Example: Differential NRZ

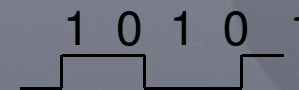

M-PAM

- Número de posibles símbolos, M , may be different to 2
 - Then Symbol and Bit take different meaning
 - If symbol duration is T , then the symbol rate is $R = 1/T$ and

$$R = R_b \cdot \frac{1}{\log_2 M}$$

$$T \equiv T_b \log_2 M$$

Error Probability of M-PAM

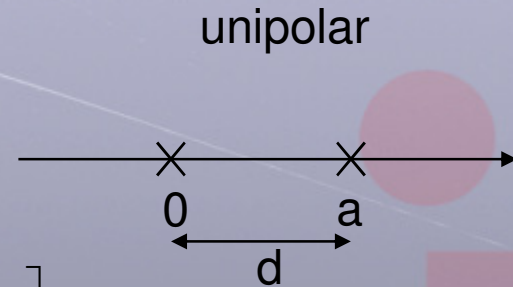
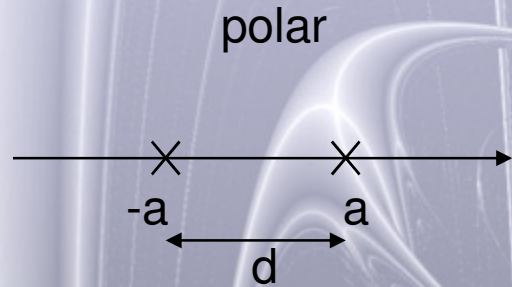

$$P_e = \frac{1}{2} \operatorname{erfc} \left[\frac{d}{2\sqrt{N_0}} \right]$$

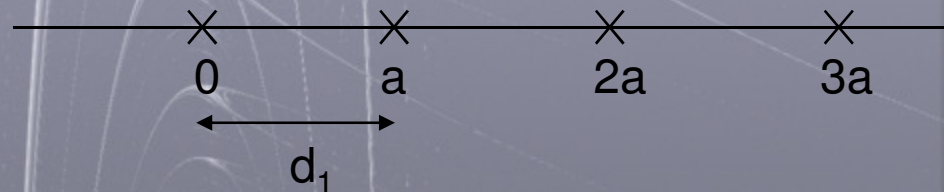

$$d_1 = a$$

$$P_e = \frac{M-1}{M} \operatorname{erfc} \left(\frac{a}{2\sqrt{N_0}} \right)$$

ISI, Pulse Conformation and Eye Diagram

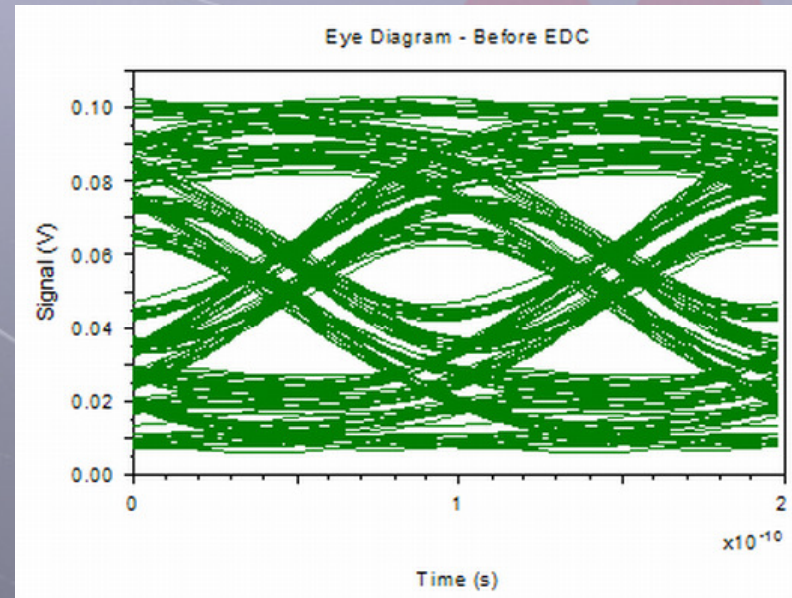
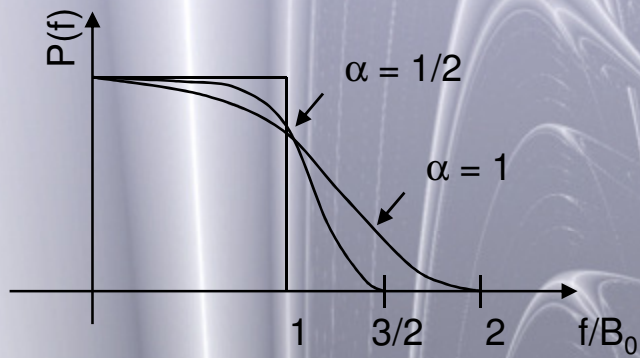

Band-Pass Modulations

- Same rationale to modulate than analog transmission
 - Band-pass channels
 - Frequency multiplexing
 - Lower noise in same bands
 - Allowing radio-transmission

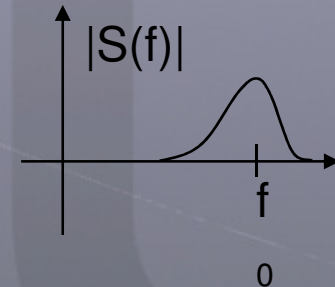
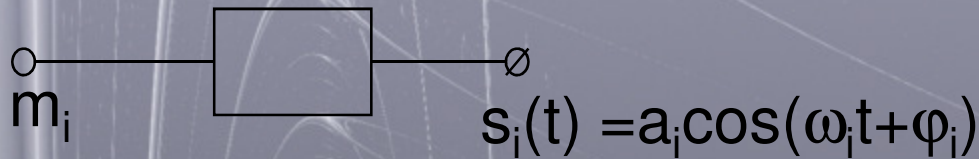

ASK (Amplitude Shift Keying)

- Transmitted symbols changing the amplitude of a carrier (and conformed pulse)
 - Constellation dimension $N=1$
 - In the simplistic case of rectangular pulse shape

$$s_i(t) = a_i \sqrt{\frac{2E_0}{T}} p(t) \cos \omega_o t$$

$$s_i(t) = a_i \sqrt{\frac{2E_0}{T}} \text{rect}(t/T) \cos \omega_o t$$

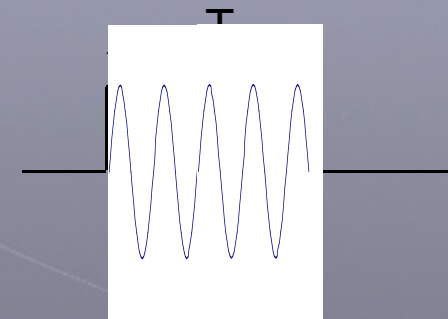

being $a_i = 0, 1, \dots, M-1$

$a_i = \pm 1, \pm 3, \pm 5, \dots, \pm M-1$

Unipolar case, or
Polar case

ASK (Amplitude Shift Keying)

- Error Probability

- Orthonormal base (N=1): $\Phi_i(t) = \sqrt{\frac{2}{T}} \cos \omega_0 t \quad 0 \leq t \leq T$
- Constellation

$$s_i(t) = a_i \cdot \sqrt{E_0} \cdot \Phi_i(t)$$

- Polar



$$S_{pico} = \frac{(M-1)^2 E_0}{T}$$

$$S = \frac{1}{T} \bar{E}_{si} = \frac{1}{T} \cdot \frac{1}{M} \sum_{i=1}^M E_{si} = \frac{M^2 - 1}{2T} \cdot E_0$$

$$d_1 = 2\sqrt{E_0}$$

$$Pe = \frac{M-1}{M} \operatorname{erfc} \left(\sqrt{\frac{E_0}{N_0}} \right)$$

- Unipolar

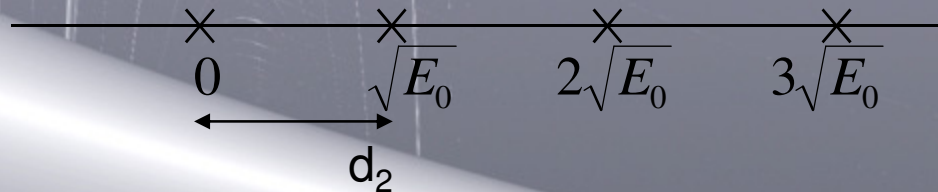

$$S_{pico} = \frac{(M-1)^2 E_0}{T}$$

$$S_{media} = \frac{1}{T} \cdot \frac{1}{M} \sum_{i=0}^{M-1} i^2 E_0 = \frac{E_0}{T} \left(\frac{1}{3} M^2 - \frac{1}{2} M + \frac{1}{6} \right)$$

$$d_2 = \sqrt{E_0}$$

$$Pe = \frac{M-1}{M} \operatorname{erfc} \left(\frac{1}{2} \sqrt{\frac{E_0}{N_0}} \right)$$

PSK (Phase Shift Keying)

- Symbols transmit information on the phase

- Dimension of the constellation N=2

$$S_i(t) = \sqrt{\frac{2E}{T}} \cos\left(\omega_0 t + \frac{2\pi}{M} i\right)$$

$$\Phi_1(t) = \sqrt{\frac{2}{T}} \cos \omega_0 t$$

$$\Phi_2(t) = \sqrt{\frac{2}{T}} \sin \omega_0 t$$

$$\omega_0 = 2\pi \cdot k \cdot \frac{1}{T}$$

$$S_i(t) = \sqrt{E} \cos \frac{2\pi}{M} i \cdot \Phi_1(t) - \sqrt{E} \sin \frac{2\pi}{M} i \cdot \Phi_2(t)$$

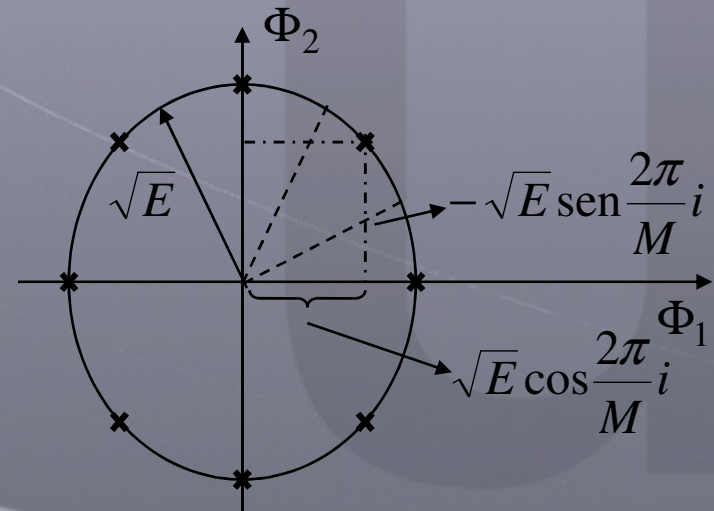

PSK (Phase Shift Keying)

- Error Probability

$$Pe = \frac{1}{M} \sum_{i=1}^M Pe(m_i) = \frac{1}{M} \iint_{\bar{z}_i} \frac{1}{(\pi N_0)} e^{-\frac{(x-\sqrt{E})^2 + y^2}{N_0}} dx dy$$

- Realizing on the rotational symmetry

$$\text{for } M \geq 4: Pe \approx \text{erfc} \left[\sqrt{\frac{E}{N_0}} \sin \left(\frac{\pi}{M} \right) \right]$$

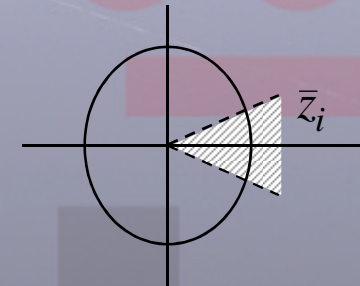

- Union Upper bound $d_{min} = \sqrt{2E} \cdot \sqrt{1 - \cos \frac{2\pi}{M}}$

$$Pe = \frac{M-1}{2} \text{erfc} \left[\frac{1}{2} \sqrt{\frac{2E}{N_0}} \cdot \sqrt{1 - \cos \frac{2\pi}{M}} \right] = \frac{M-1}{2} \text{erfc} \left[\sqrt{\frac{E}{2N_0}} \cdot \sqrt{1 - \cos \frac{2\pi}{M}} \right]$$

PSK (Phase Shift Keying)

BPSK ($M = 2$)

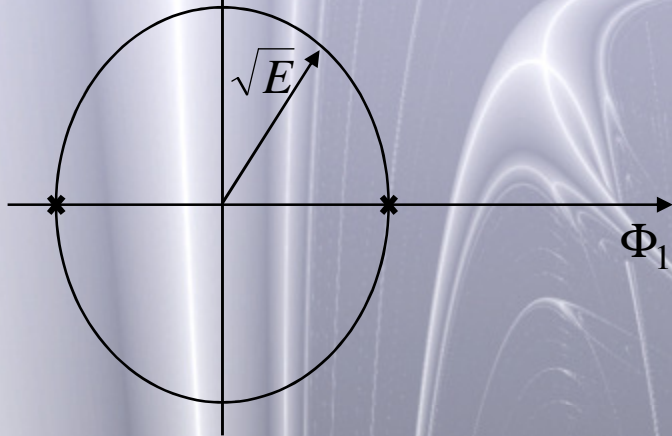

$$Pe = \frac{1}{2} \operatorname{erfc} \left[\sqrt{\frac{E}{N_0}} \right]$$

QPSK ($M = 4$)

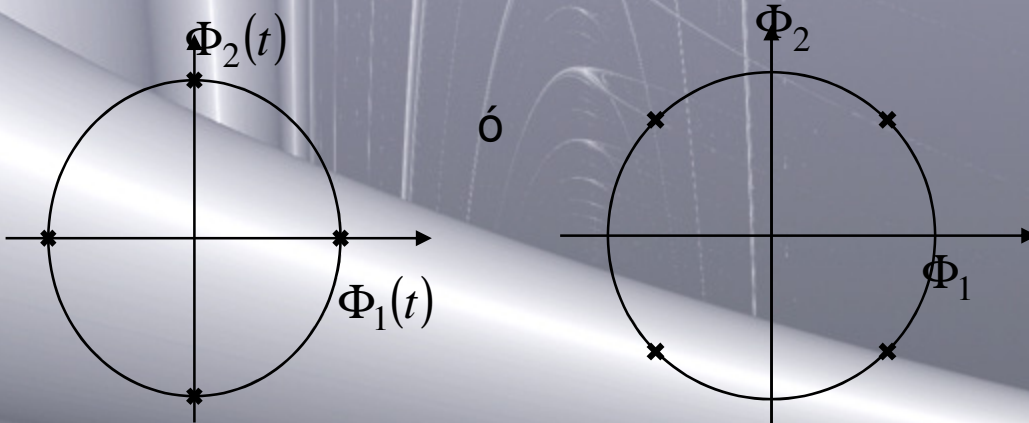

$$Pe = \operatorname{erfc} \left[\sqrt{\frac{E}{2N_0}} \right]$$

QAM (Quadrature Amplitude Modulation)

- Symbols incorporate info in amplitude and phase

$$s_i(t) = a_i \sqrt{\frac{2E_0}{T}} \cos(\omega_0 t + \varphi_i)$$

– Constellation of dimension N=2 $\Phi_1(t) = \sqrt{\frac{2}{T}} \cos \omega_0 t$

$$\Phi_2(t) = \sqrt{\frac{2}{T}} \sin \omega_0 t$$

$$0 \leq t \leq T$$

$$s_i(t) = a_i \sqrt{E_0} \cos \varphi_i \Phi_1(t) - a_i \sqrt{E_0} \sin \varphi_i \Phi_2(t) = b_i \sqrt{E_0} \Phi_1(t) - c_i \sqrt{E_0} \Phi_2(t)$$

$$b_i = \pm 1, \pm 3, \pm 5, \dots, \pm L-1$$

$$c_i = \pm 1, \pm 3, \dots, \pm L-1$$

$$L = \sqrt{M}$$

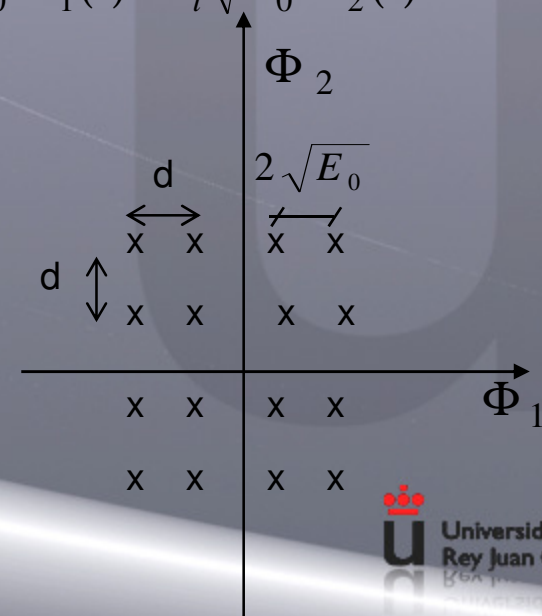

QAM (Quadrature Amplitude Modulation)

- Error Probability
 - Equivalent to 2 orthogonal ASKs

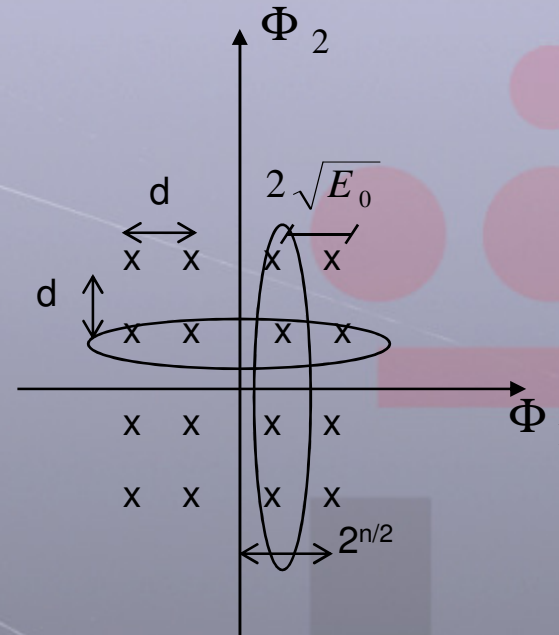

$$Pe = 2Pe^{ASK} = 2 \cdot \frac{L-1}{L} \operatorname{erfc} \left(\sqrt{\frac{E_0}{N_0}} \right) = 2 \cdot \frac{\sqrt{M}-1}{\sqrt{M}} \operatorname{erfc} \left(\sqrt{\frac{E_0}{N_0}} \right)$$

FSK (Frequency Shift Keying)

- Symbols transmit info on the frequency

$$s_i(t) = \sqrt{\frac{2E}{T}} \cos(2\pi f_i t)$$

$$f_i = \frac{n_c + i}{T}$$

- Constellation of dimension $N=M$

$$\Phi_i(t) = \frac{1}{\sqrt{E}} \cdot s_i(t)$$

$$\langle s_i(t), s_j(t) \rangle = E \delta_{ij}$$

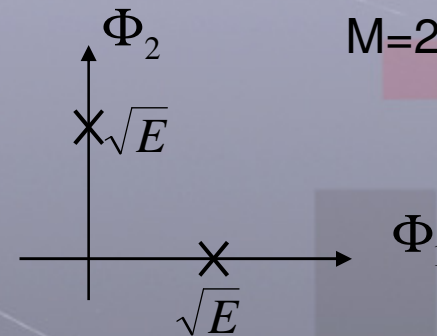

- Symbol Error Probability

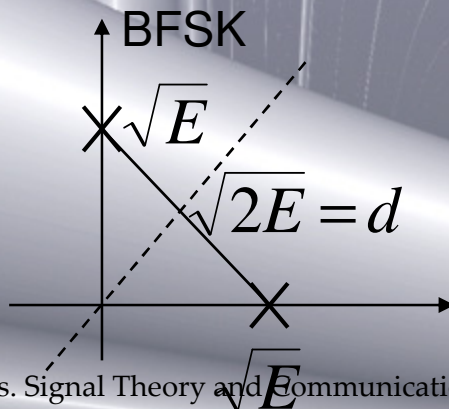

$$Pe = \frac{M-1}{2} \operatorname{erfc}\left(\frac{d_{min}}{2\sqrt{N_0}}\right) = \frac{M-1}{2} \operatorname{erfc}\left(\sqrt{\frac{E}{N_0}}\right)$$

$$S = \frac{E}{T}$$

Spectral Efficiency and Bandwidth

$$\rho = \frac{R_b}{B}$$

- ASK, PSK, QAM

$$B = \frac{2}{T} = \frac{2}{T_b \log_2 M}$$

$$\rho = \frac{1/T_b}{2/T_b \log_2 M} = \frac{\log_2 M}{2}$$

- MSK

$$B = \frac{1}{2T} M = \frac{1}{2T_b \log_2 M} M$$

$$\rho = \frac{1/T_b}{1/2T \cdot M} = \frac{2 \log_2 M}{M}$$

- FSK

$$B = \frac{1}{2T} M = \frac{1}{2T_b \log_2 M} \cdot M$$

$$\rho = \frac{\log_2 M}{M}$$

(assuming rectangular pulses and Bandwidth to the first null)

Multiple Access

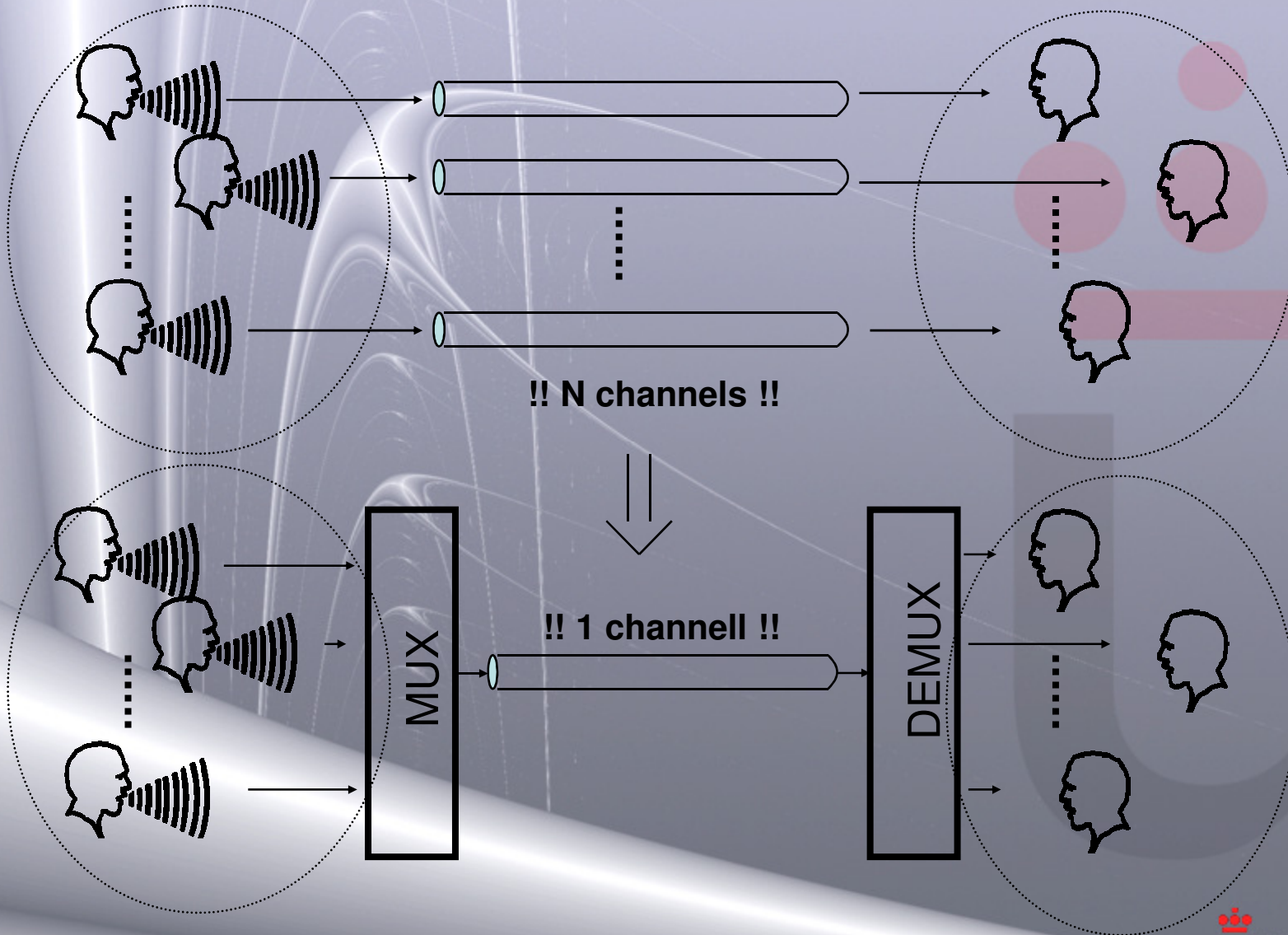

Multiple Access

- In telecommunications, time and bandwidth are scarce resources
 - Time and Bandwidth have to be managed efficiently
 - To not waste them
 - To distribute equitatively among users
- When multiple users trying to access the same resources
 - Several topologies possible
 - Peer-to-Peer; Broadcast, Many-to-One; Multicast; ...
- Alternatives
 - Multiplexing → resources are assigned a priori; fixed assignment or very slow changes
 - Multiple Access → dynamic assignation. A controller may distribute the access to the resources among potential users

Duplexing

- Coexistence of:
 - Up Link (UL):
 - Multiple Access Channel (MAC)
 - Down Link (DL):
 - Broadcast Channel (BC)
- Alternative techniques:
 - TDD (Time Division Duplex)
 - Lower Hw complexity but larger flexibility and possible only for digital transmissions
 - FDD (Frequency Division Duplex).
 - More Hw complexity. Appropriate for large links

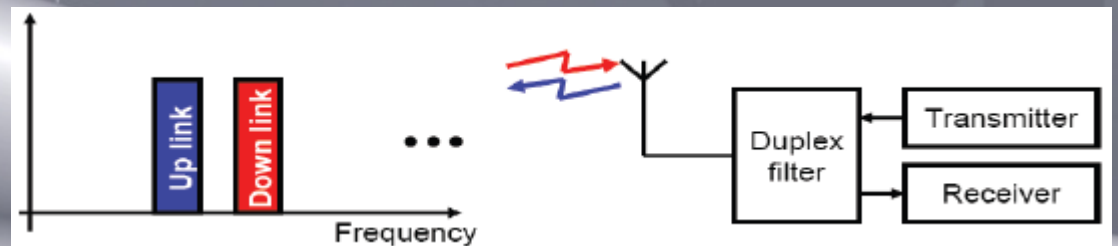
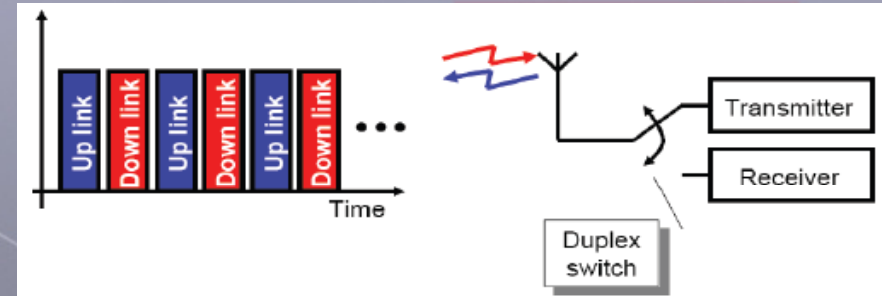

Multiple Access

- Contentionless Techniques (supervised) :
 - Resources Pre-assigned to users
 - Pre-established rules
 - Deterministic access
 - Adequate for regular streams
 - Capable to guaranty the QoS, but risk of outage
- Contention Techniques (under demand):
 - Users decide when to take resources from the channel
 - Stochastic access
 - Adequate for irregular streams

Contentionless Techniques (supervised)

- Usefull when there is infrastructure and the users transmit regularly
- It requires larger maintenance but performance is guarantied
- Clear rules about when a user should transmit
- Different users can be discrimitaed by
 - Frequency: FDMA
 - Time: TDMA
 - Code: CDMA
 - Space: SDMA

Frequency Division Multiple Access. FDMA.

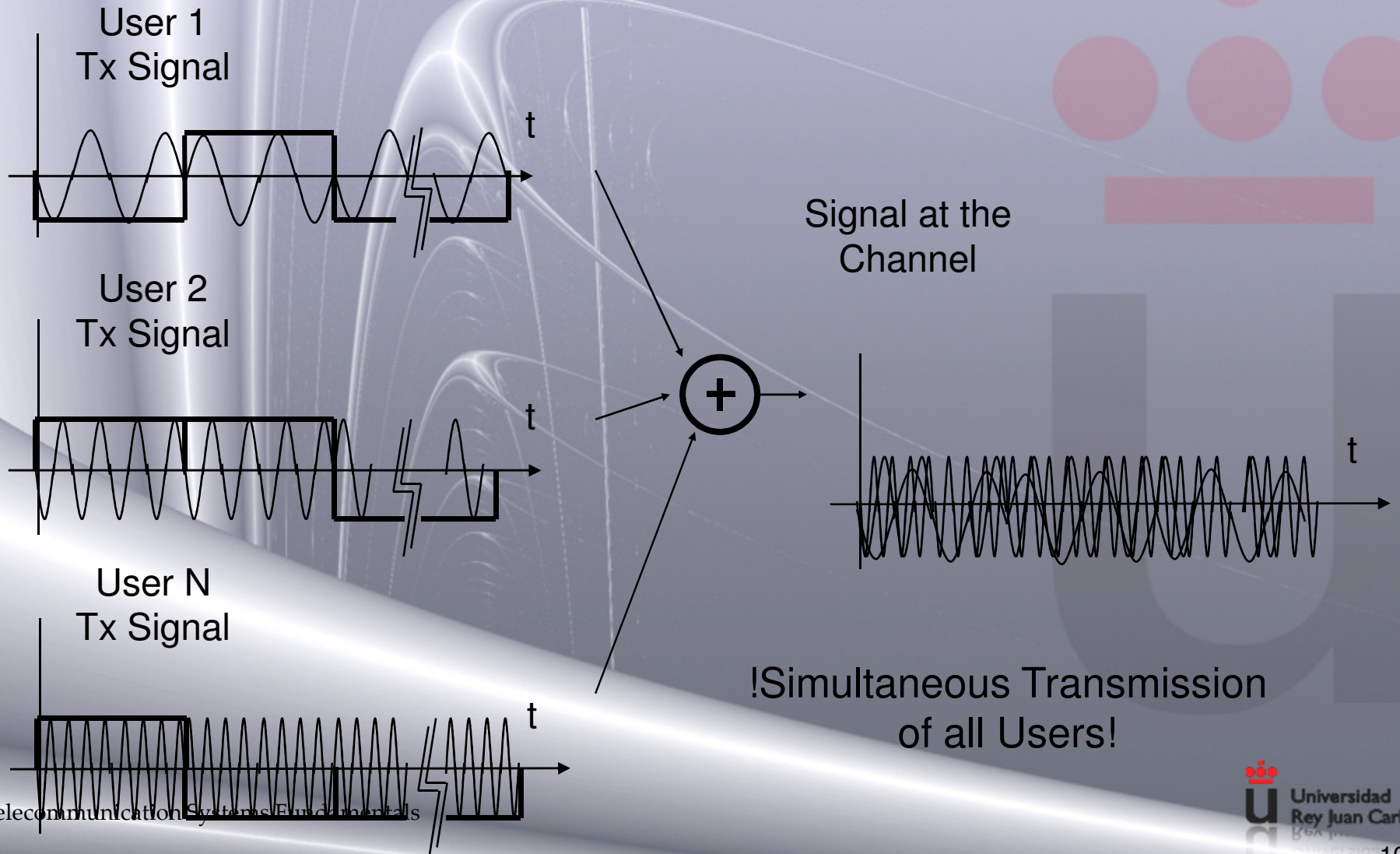

Frequency Division Multiple Access. FDMA.

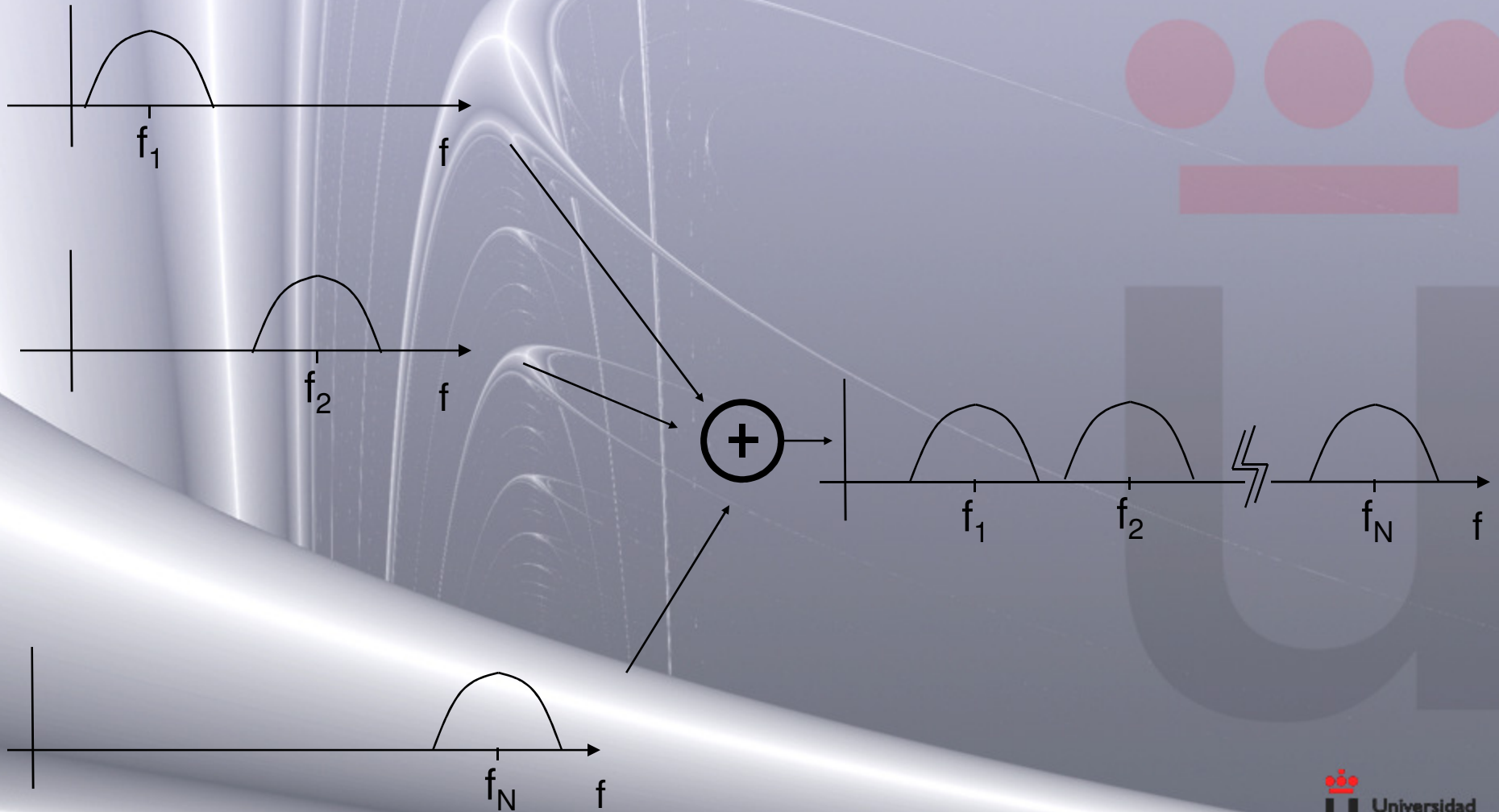

Frequency Division Multiple Access. FDMA.

- Available Bandwidth is divided into sub-bands
 - Each user is assigned to a sub-band → orthogonal access
- Characteristics
 - Simple time synchronization
 - Strict frequency alignment required
 - Sensible to frequency alterations: Doppler shift, intermodulations, clock drift, etc.
- Used on
 - Analogue systems
 - Broadband access where the sub-band assigned are large
 - Large radio coverage where time division show low efficiency
 - Combination with other Multiple Access techniques
- Alterations:
 - OFDMA:
 - Each OFDM user is assigned with a different sub-carrier set
 - SC-FDMA:
 - Similar to OFDM but pre-coding symbols using a DFT
 - Gets some advantages and better performance

Time Division Multiple Access. TDMA.

- Each user is assigned different time interval – time slot
 - Orthogonal Access
- Characteristics
 - Complex Time synchronization
 - Simple frequency synchronization
 - Each user occupies all the available bandwidth, so it can cope easily with frequency selective fading – interleaving
 - Users can use non-transmitting slots to measure the channel or perform other signaling tasks
- Typically combined with FDMA
 - Example: GSM.
 - Typical Base Station: 3 frequency channels (duplex) (FDMA), each channel shared by 8 users using TDMA → Each BS can serve 24 simultaneous users

Time Division Multiple Access. TDMA.

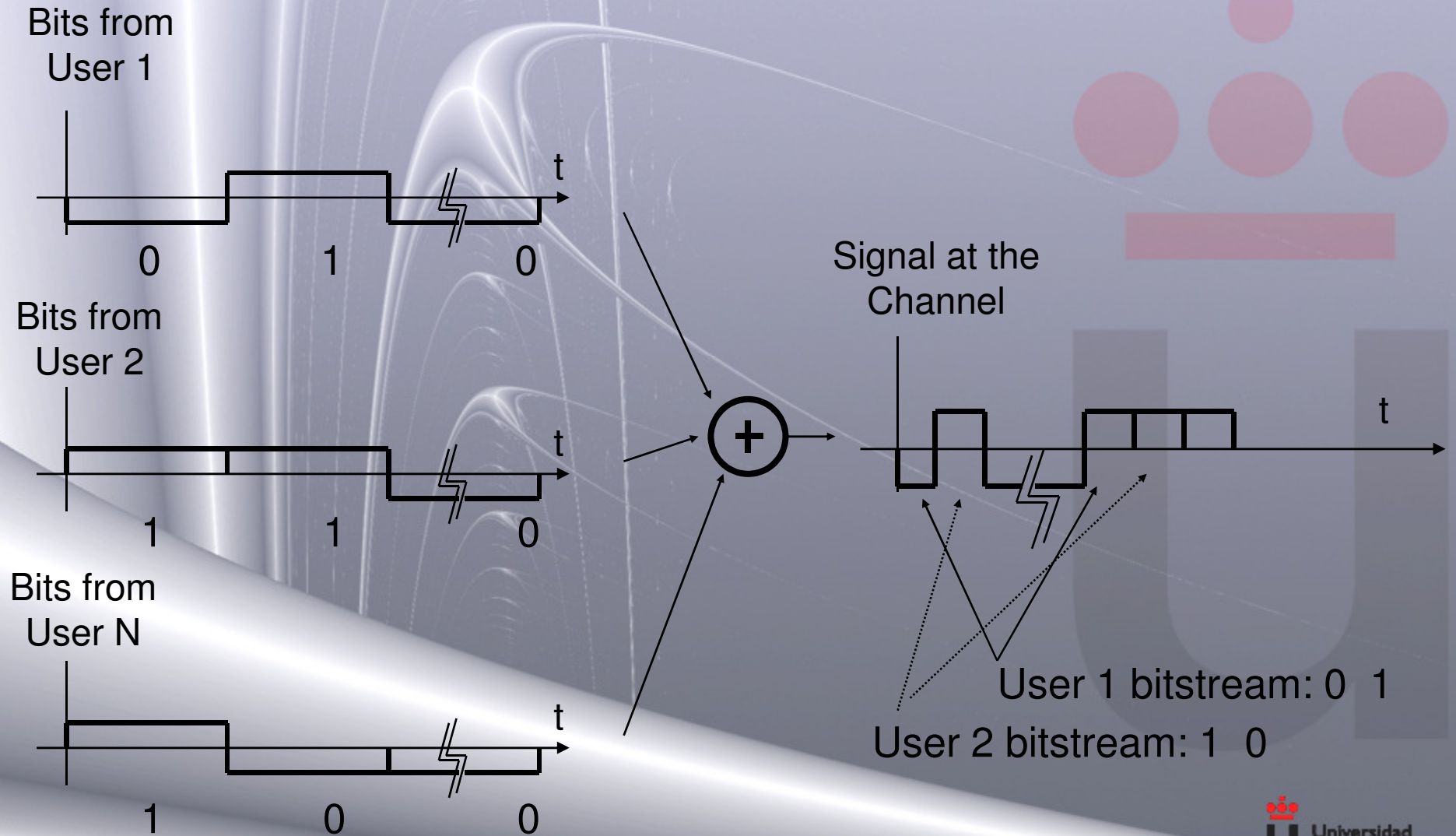

Code Division Multiple Access. CDMA.

- Users access same spectrum at anytime but using different codes
- Characteristics
 - Orthogonal codes
 - Maximum number of users limited by the number of codes
 - Sensible to time synchronization
 - Free of inter-user interference (not when multipath)
 - Non-orthogonal codes
 - Maximum number of users limited by SIR
 - Not sensible to time sync
 - System capacity is limited by interferences
 - UL is the usual limitation because its lack of sync

$$SIR = \frac{R_c / R_b}{M - 1}$$

Code Division Multiple Access. CDMA.

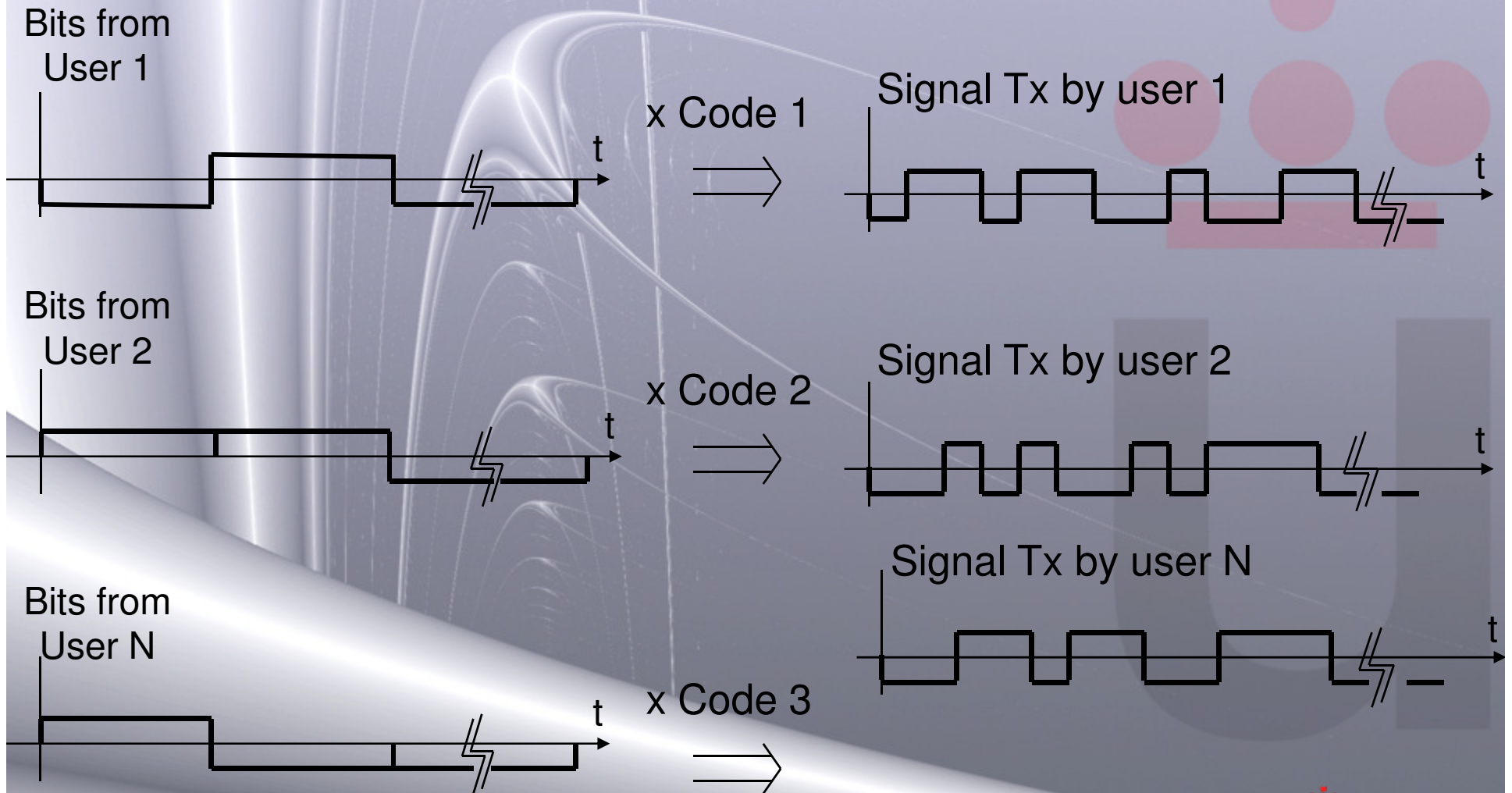

Code Division Multiple Access. CDMA.

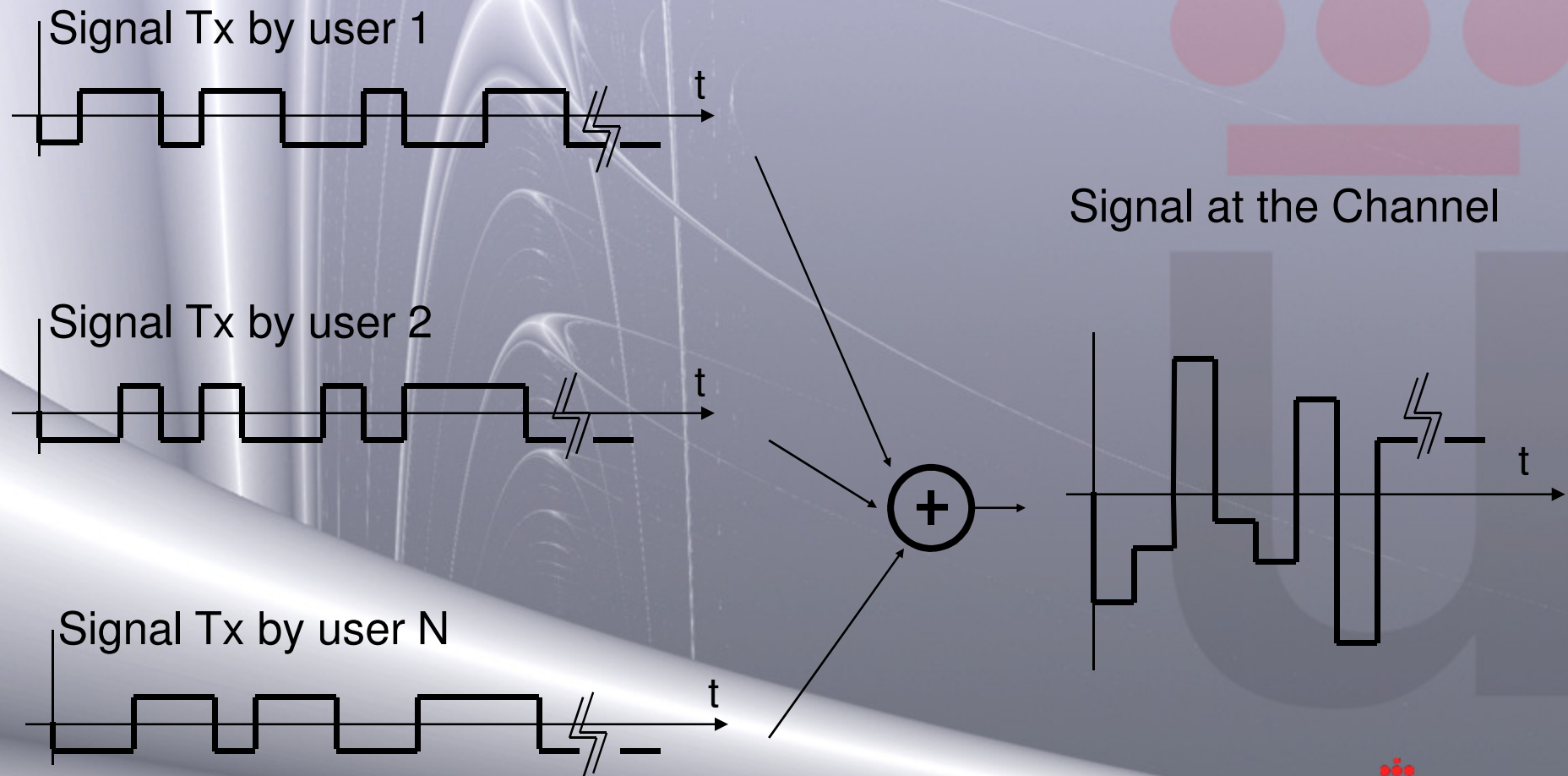

Space Division Multiple Access. SDMA.

- By using directive or multiple antennas, they can be steered towards some directions
 - Some of the names for such systems are: adaptive antenna, MIMO (Multiple-Input Multiple-Output), MISO, Beamforming, etc (they do not mean the same).
- Characteristics
 - Larger complexity for Tx and Rx
 - The larger the antenna the better the performance

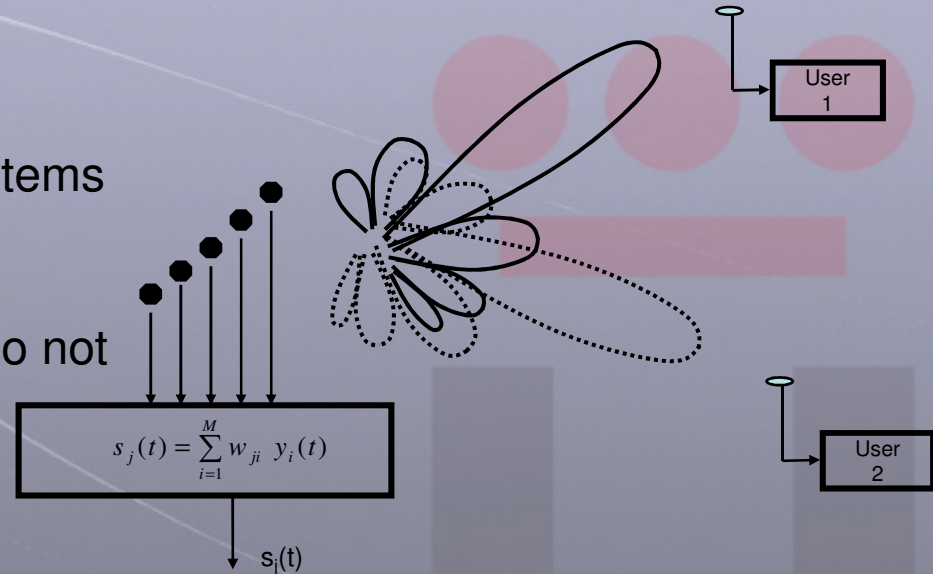

Contention Multiple Access (Unsupervised)

- Under demand techniques
 - No pre-assignment of resources → users decide when transmit
 - Users may collide - collision
- Effective when users streams are irregular (burst traffic)
 - Probabilistic access
 - Not possible to guaranty instantaneous QoS
- Widely used because its simplicity and efficiency
 - Local Area Networks: ex. Ethernet or WiFi
- Most common techniques
 - Aloha / Slotted Aloha
 - Carrier Sense Multiple Access (CSMA)

Contention Protocols

- **ALOHA**

- Developed in the 1970s for a packet radio network by Hawaii University.
- Whenever a station has a data, it transmits
- Sender finds out whether transmission was successful or experienced a collision by listening to the broadcast from the destination station
- Sender retransmits after some random time if there is a collision.

- **Slotted ALOHA**

- Improvement: Time is slotted and a packet can only be transmitted at the beginning of one slot
- It reduces the collision probability

Contention Protocols

- **CSMA** (Carrier Sense Multiple Access)
 - Improvement: Start transmission only if no transmission is ongoing
- **CSMA/CD** (CSMA with Collision Detection)
 - Improvement: Stop ongoing transmission if a collision is detected
- **CSMA/CA** (CSMA with Collision Avoidance)
 - Improvement: Wait a random time and try again when carrier is quiet. If still quiet, then transmit
- **CSMA/CA with ACK**
- **CSMA/CA with RTS/CTS**

ALOHA

- Collision mechanism in ALOHA

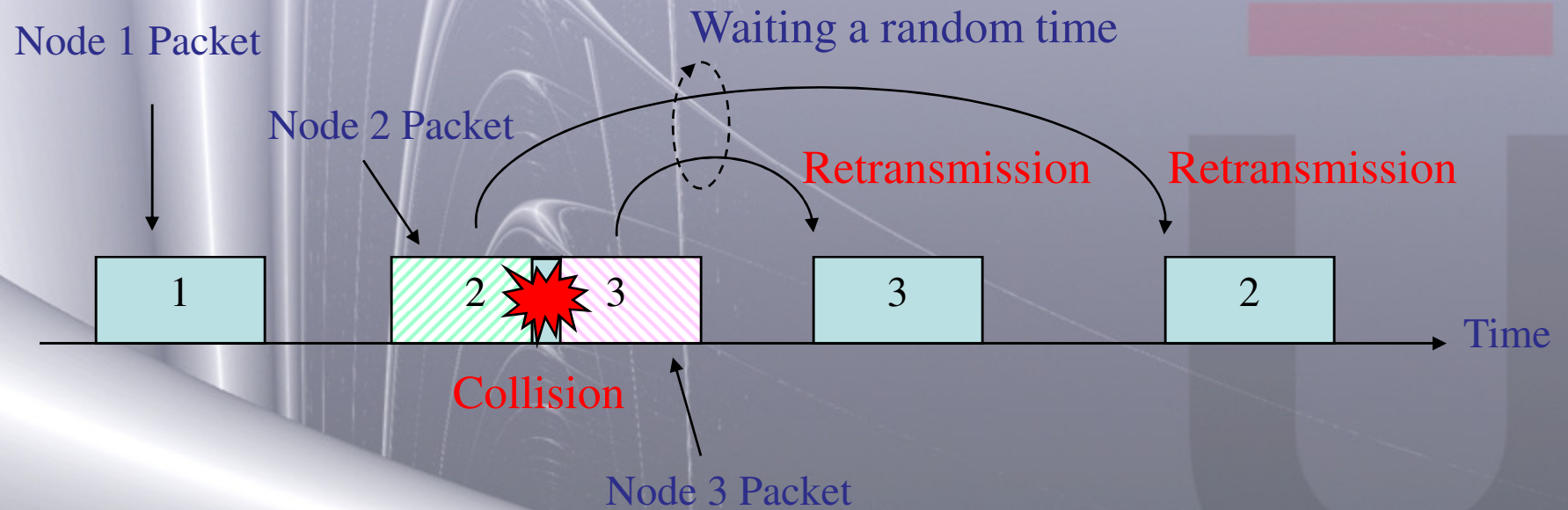

Throughput of ALOHA

- The probability that n packets arrive in two packets time is given by

$$P(n) = \frac{(2G)^n e^{-2G}}{n!}$$

where G is traffic load

- The probability $P(0)$ that a packet is successfully received without collision is calculated by letting $n=0$

$$P(0) = e^{-2G}$$

- We can calculate throughput S with a traffic load G as follows:

$$S = G \cdot P(0) = G \cdot e^{-2G}$$

- The Maximum throughput of ALOHA is

$$S_{\max} = \frac{1}{2e} \approx 0.184$$

Slotted ALOHA

- Collision mechanism in slotted ALOHA

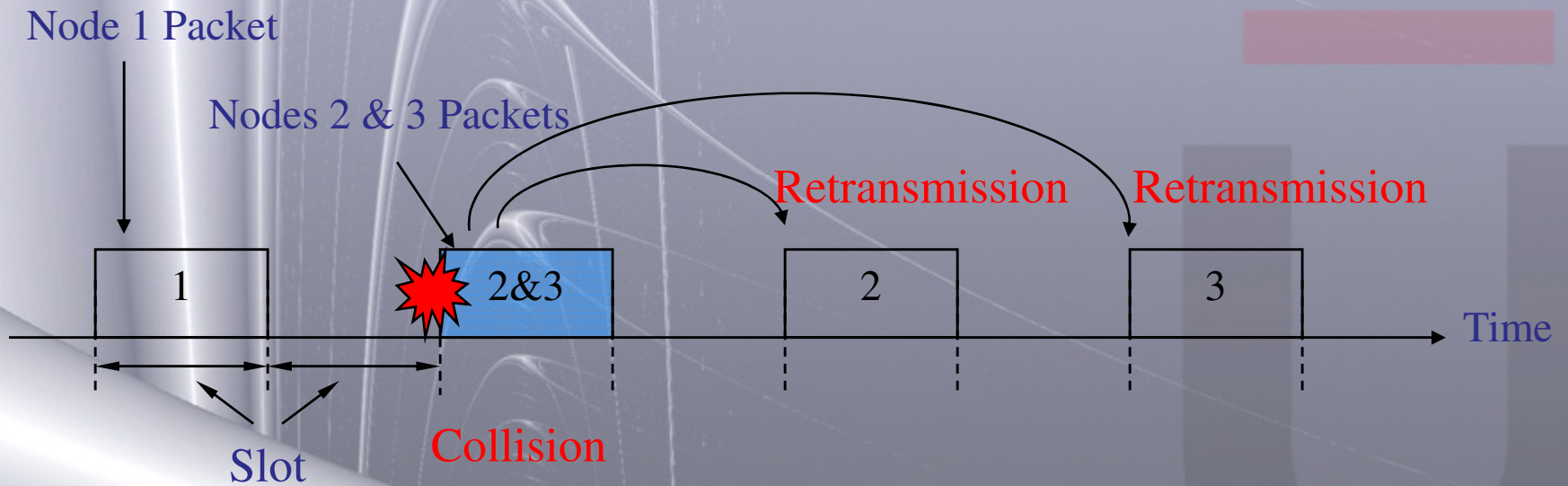

Throughput of Slotted ALOHA

- The probability of no collision is given by

$$P(0) = e^{-G}$$

- The throughput S is

$$S = G \cdot P(0) = G \cdot e^{-G}$$

- The Maximum throughput of slotted ALOHA is

$$S_{\max} = \frac{1}{e} \approx 0.368$$

Aloha and Slotted Aloha Throughput

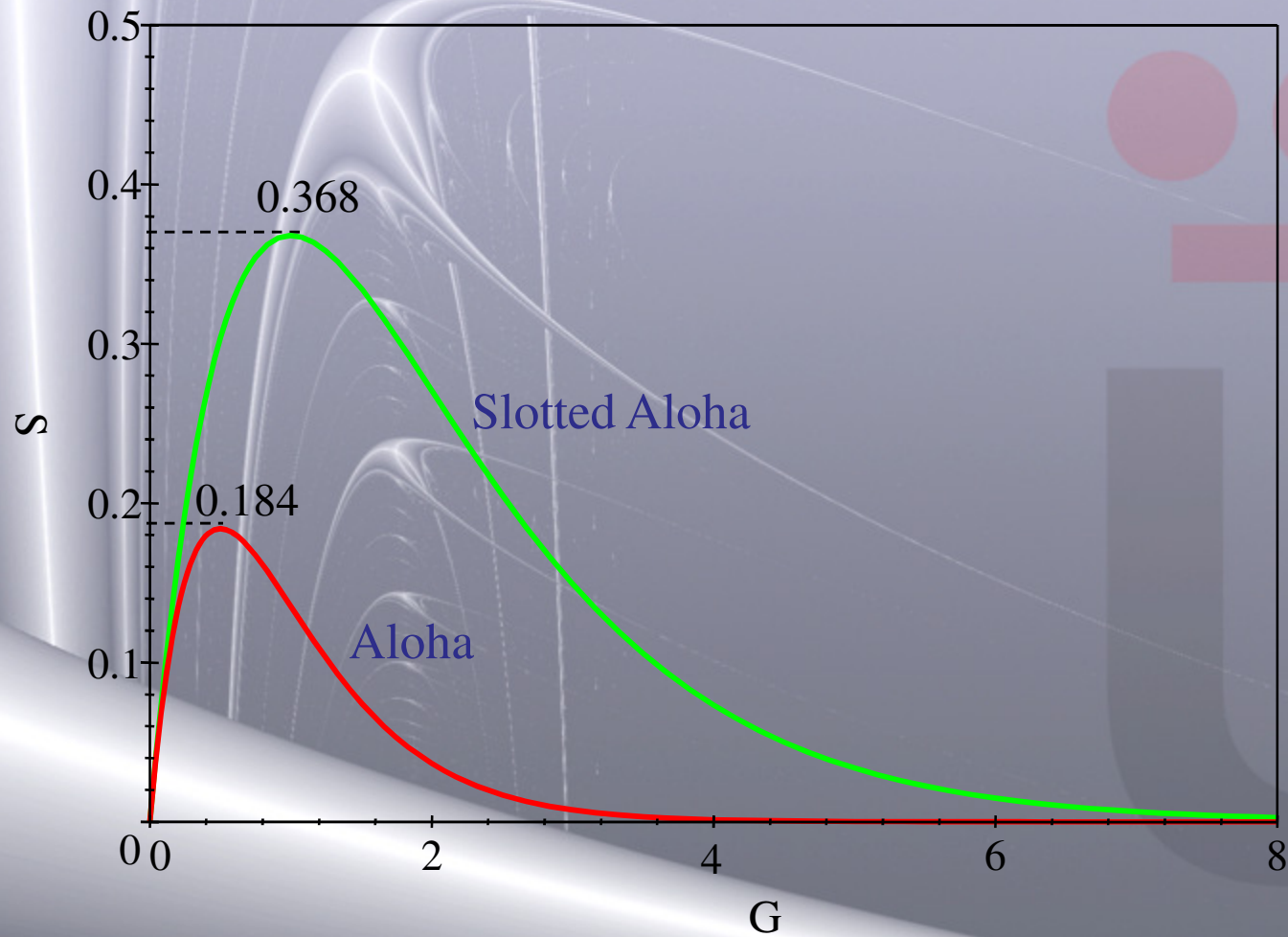

CSMA (Carrier Sense Multiple Access)

- Max throughput achievable by slotted ALOHA is 0.368.
- CSMA gives improved throughput compared to Aloha protocols.
- Listens to the channel before transmitting a packet (avoid avoidable collisions).

CSMA

- Collision Mechanism

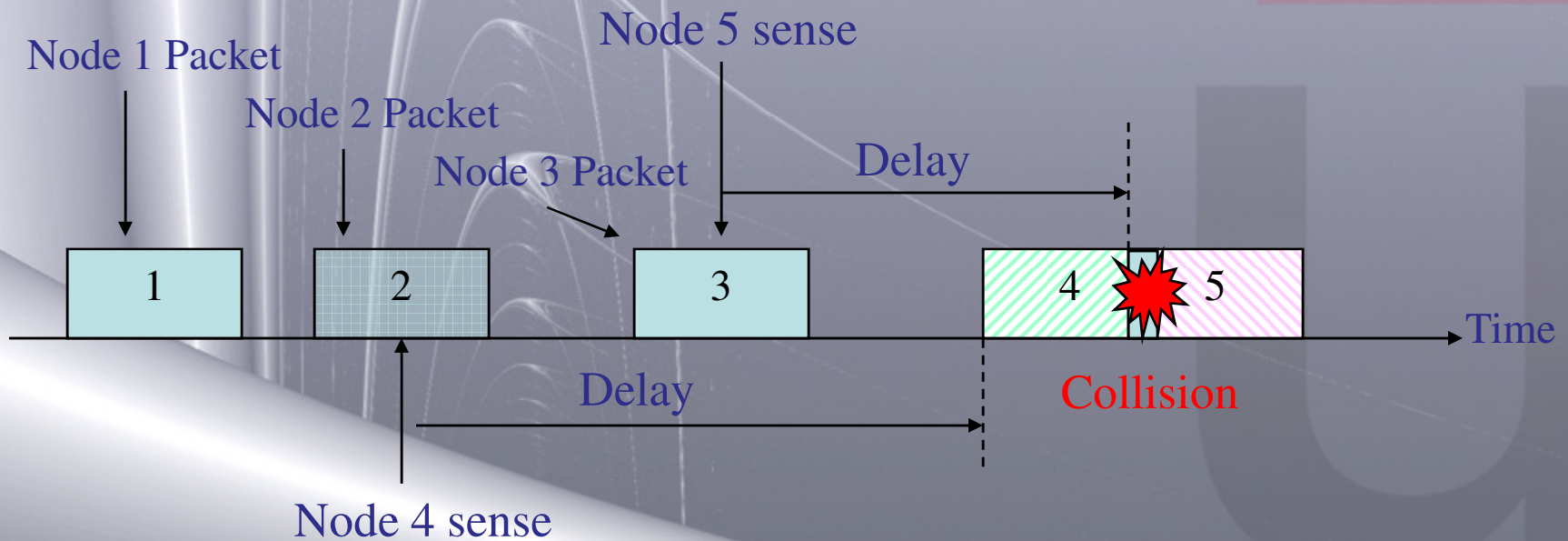

Kinds of CSMA

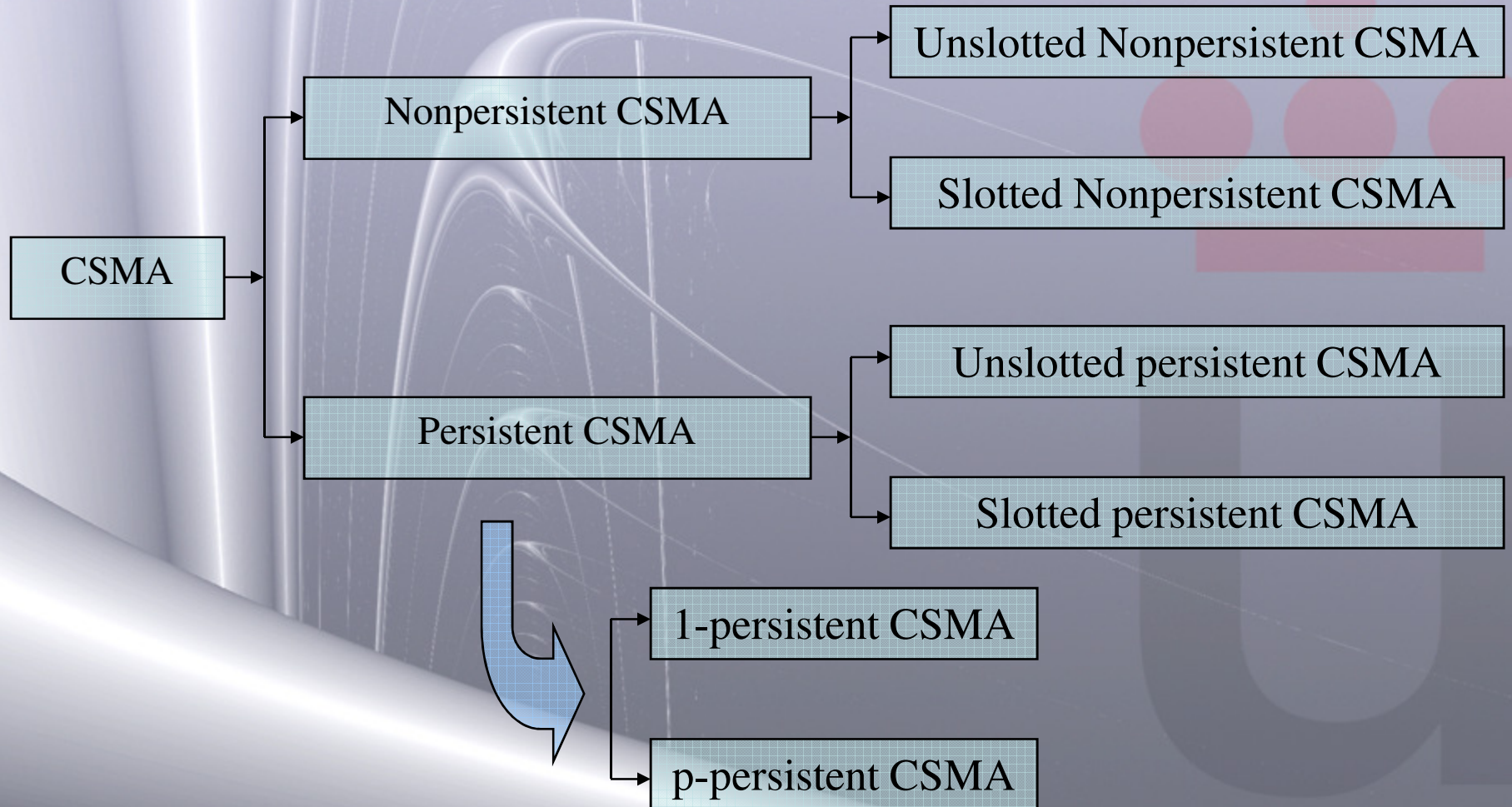

Nonpersistent/x-persistent CSMA Protocols

- Nonpersistent CSMA Protocol:
 - Step 1:** If the medium is idle, transmit immediately
 - Step 2:** If the medium is busy, wait a random amount of time and repeat **Step 1**
 - Random backoff reduces probability of collisions
 - Waste idle time if the backoff time is too long
- 1-persistent CSMA Protocol:
 - Step 1:** If the medium is idle, transmit immediately
 - Step 2:** If the medium is busy, continue to listen until medium becomes idle, and then transmit immediately
 - There will always be a collision if two nodes want to retransmit
(usually you stop transmission attempts after few tries)

Nonpersistent/x-persistent CSMA Protocols

- p-persistent CSMA Protocol:

Step 1: If the medium is idle, transmit with probability p , and delay for worst case propagation delay for one packet with probability $(1-p)$

Step 2: If the medium is busy, continue to listen until medium becomes idle, then go to **Step 1**

Step 3: If transmission is delayed by one time slot, continue with **Step 1**

- A good tradeoff between nonpersistent and 1-persistent CSMA

How to Select Probability p ?

- Assume that N nodes have a packet to send and the medium is busy
- *Then*, Np is the expected number of nodes that will attempt to transmit once the medium becomes idle
- If $Np > 1$, then a collision is expected to occur

Therefore, network must make sure that $Np < 1$ to avoid collision, where N is the maximum number of nodes that can be active at a time

Contention Protocols

- Throughput

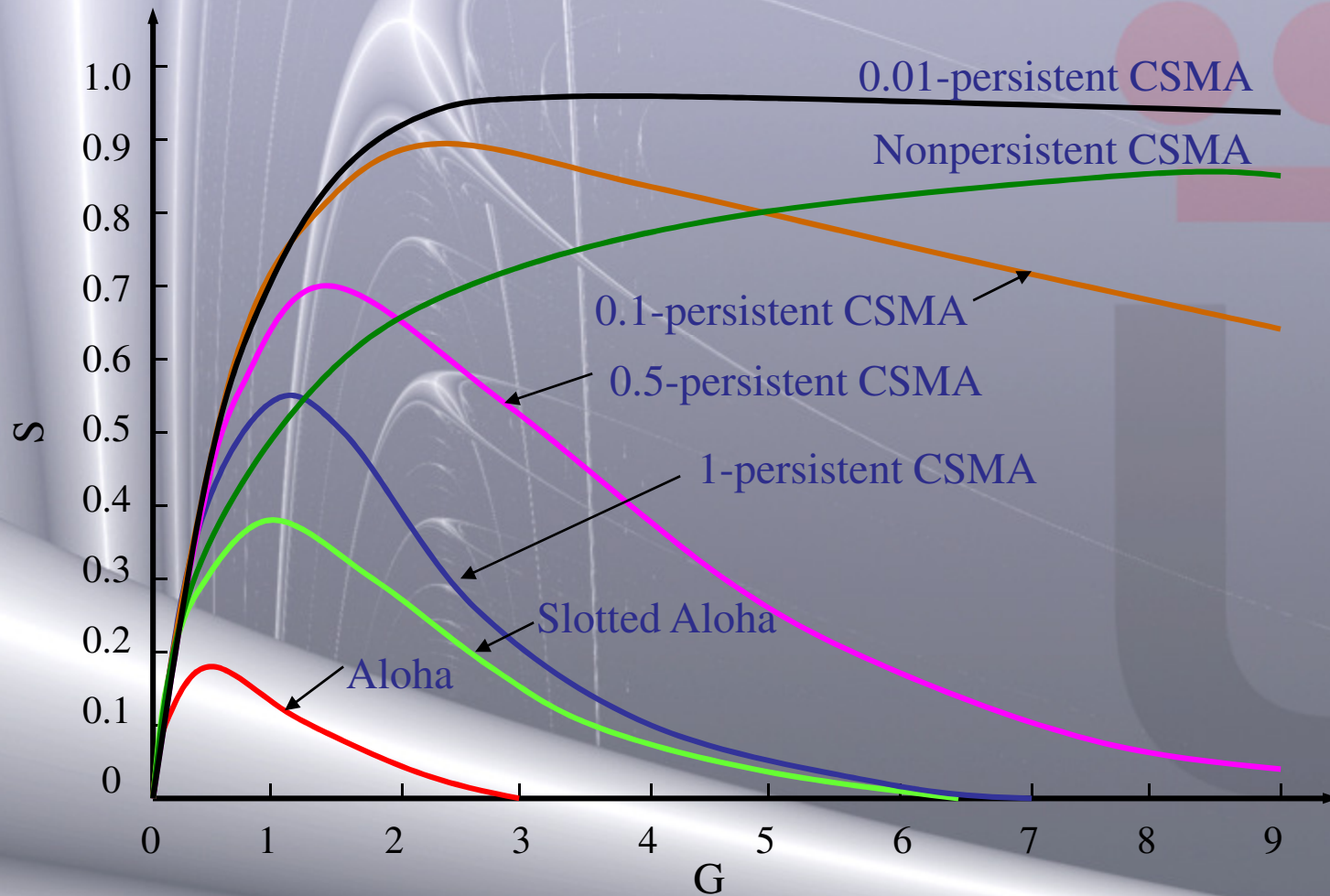

CSMA/CD (CSMA with Collision Detection)

- In CSMA, if 2 terminals begin sending packet at the same time, each will transmit its complete packet (although collision is taking place).
- Wasting medium for an entire packet time.

- CSMA/CD

Step 1: If the medium is idle, transmit

Step 2: If the medium is busy, continue to listen until the channel is idle then transmit

Step 3: If a collision is detected during transmission, cease transmitting

Step 4: Wait a random amount of time and repeats the same algorithm

CSMA/CD

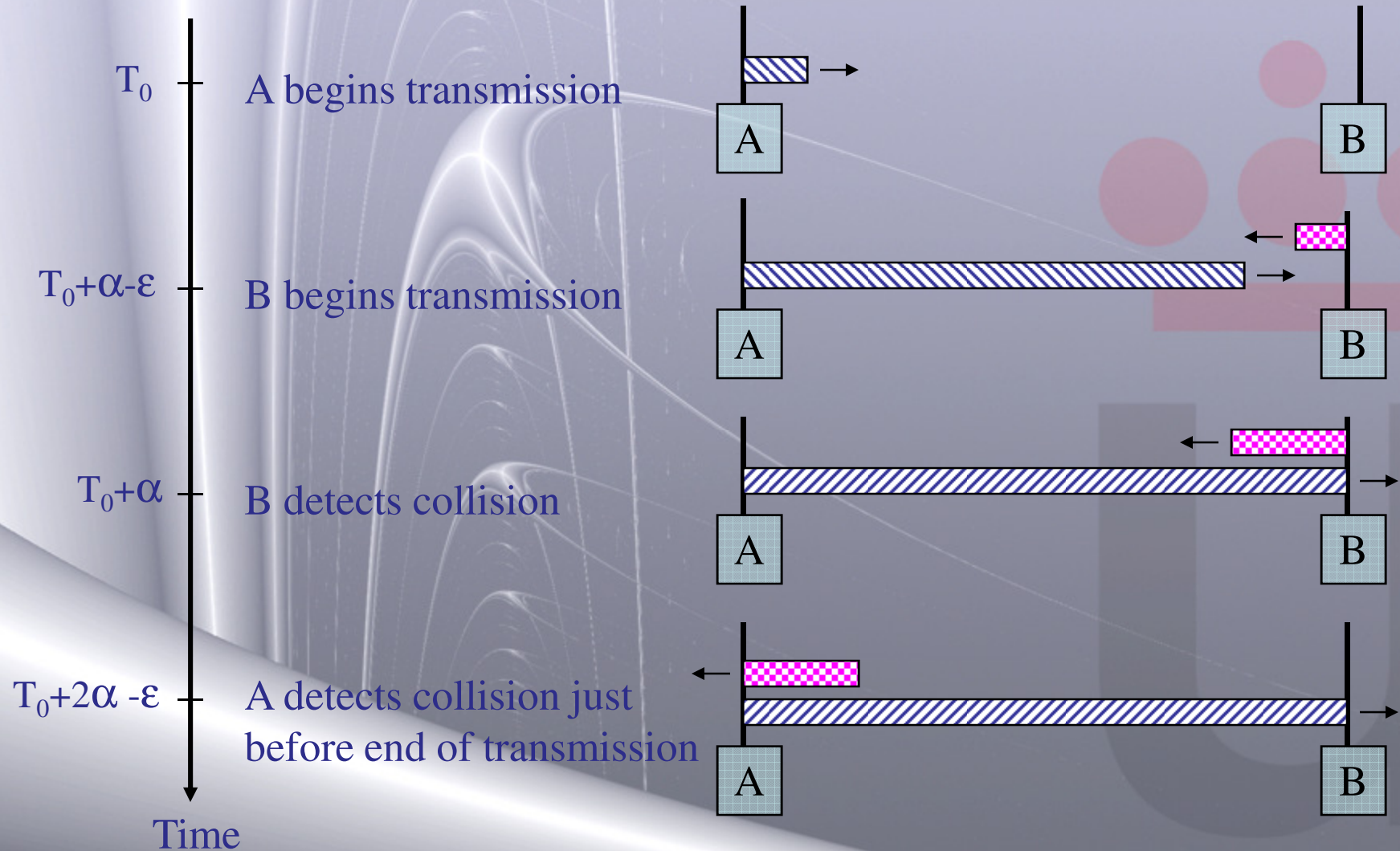

(α is the propagation time)

CSMA/CA (CSMA with collision Avoidance)

- All terminals listen to the same medium as CSMA/CD
- Terminal ready to transmit senses the medium
- If medium is busy it waits until the end of current transmission
- It again waits for an additional predetermined time period DIFS (Distributed inter frame Space)
- Then picks up a random number of slots (the initial value of backoff counter) within a contention window to wait before transmitting its frame
- If there are transmissions by other terminals during this time period (backoff time), the terminal freezes its counter
- It resumes count down after other terminals finish transmission + DIFS. The terminal can start its transmission when the counter reaches to zero

CSMA/CA

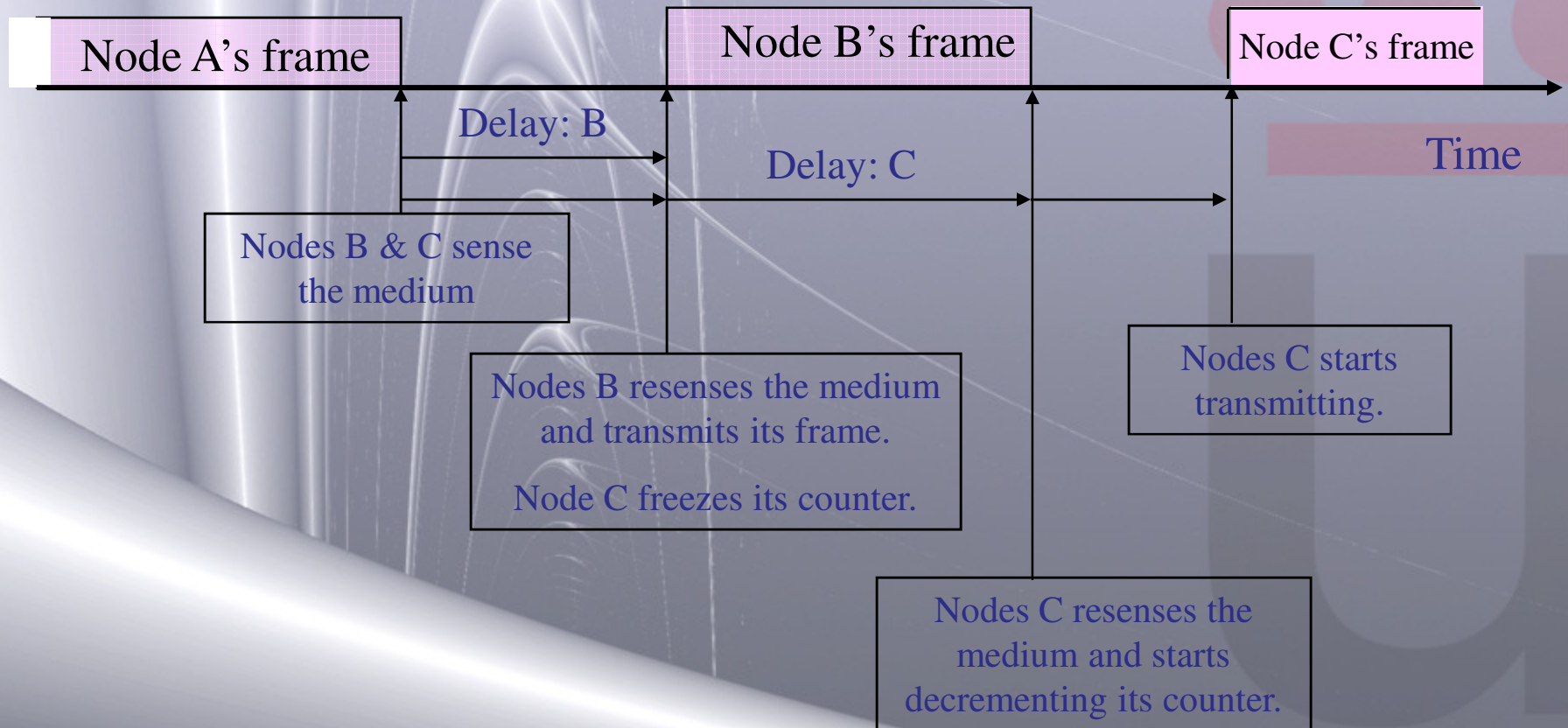

CSMA/CA

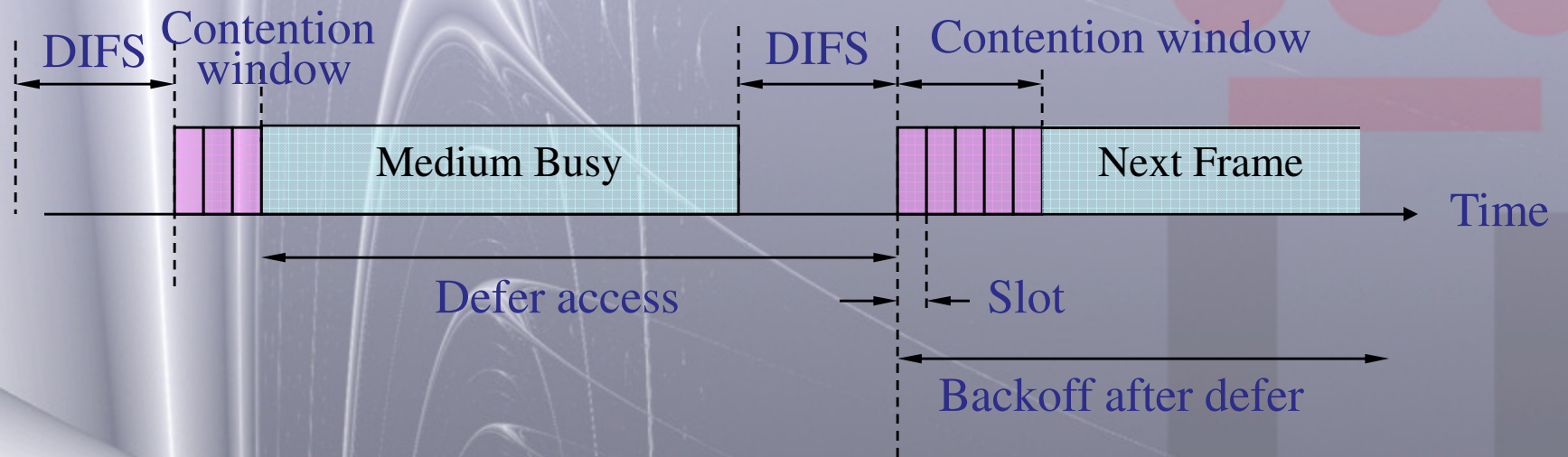

DIFS – Distributed Inter Frame Spacing

CSMA/CA with ACK

- Immediate Acknowledgements from receiver upon reception of data frame without any need for sensing the medium.
- ACK frame transmitted after time interval SIFS (*Short Inter-Frame Space*) ($SIFS < DIFS$)
- Receiver transmits ACK without sensing the medium.
- If ACK is lost, retransmission done.

CSMA/CA/ACK

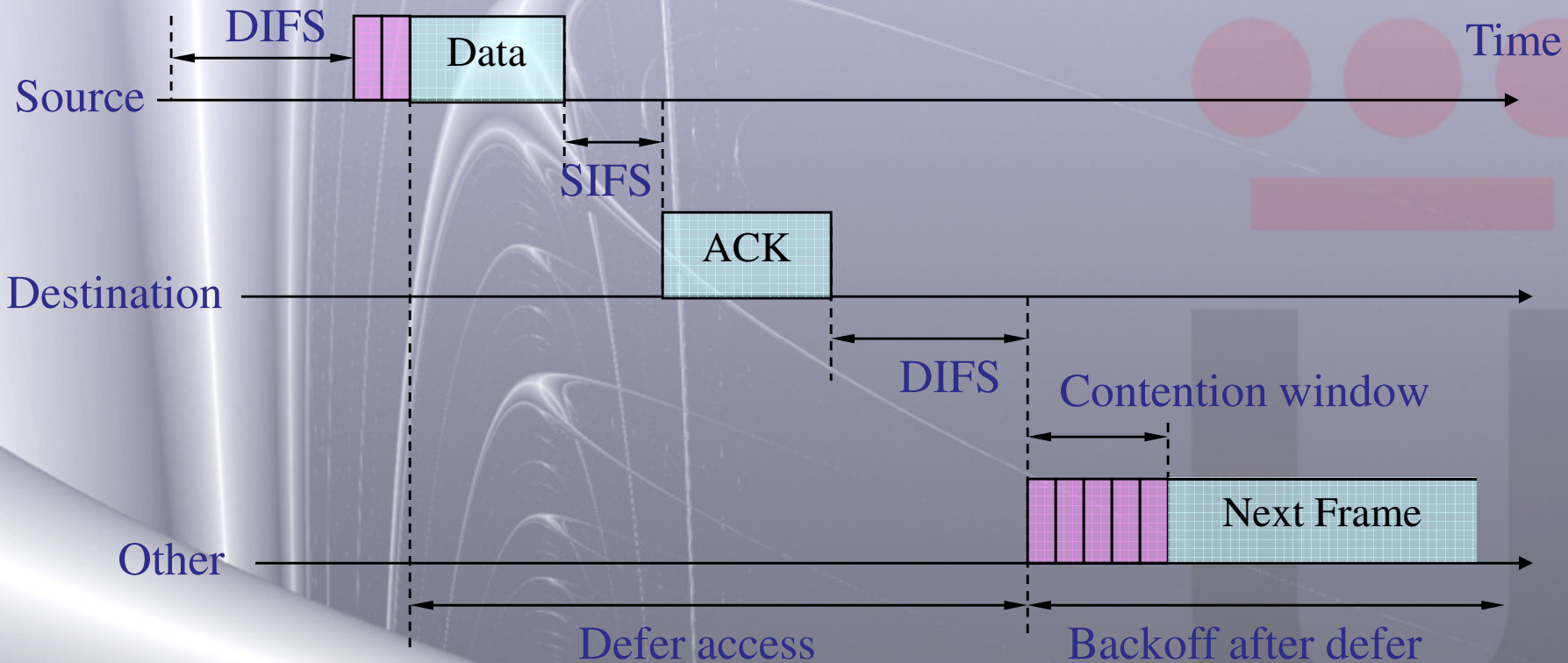

SIFS – Short Inter Frame Spacing

CSMA/CA with RTS/CTS

- Transmitter sends an RTS (request to send) after medium has been idle for time interval more than DIFS.
- Receiver responds with CTS (clear to send) after medium has been idle for SIFS.
- Then Data is exchanged.
- RTS/CTS is used for reserving channel for data transmission so that the collision can only occur in control message.

CSMA/CA with RTS/CTS

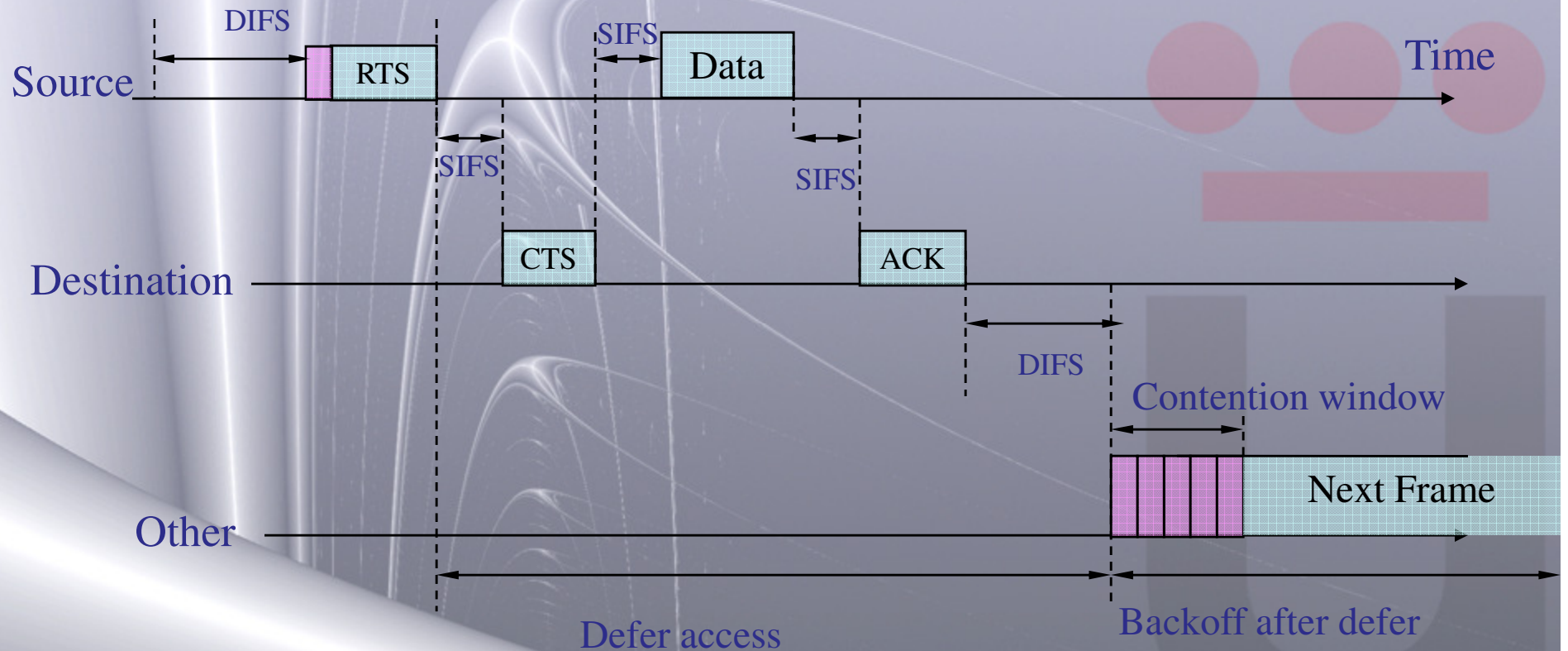

RTS/CTS

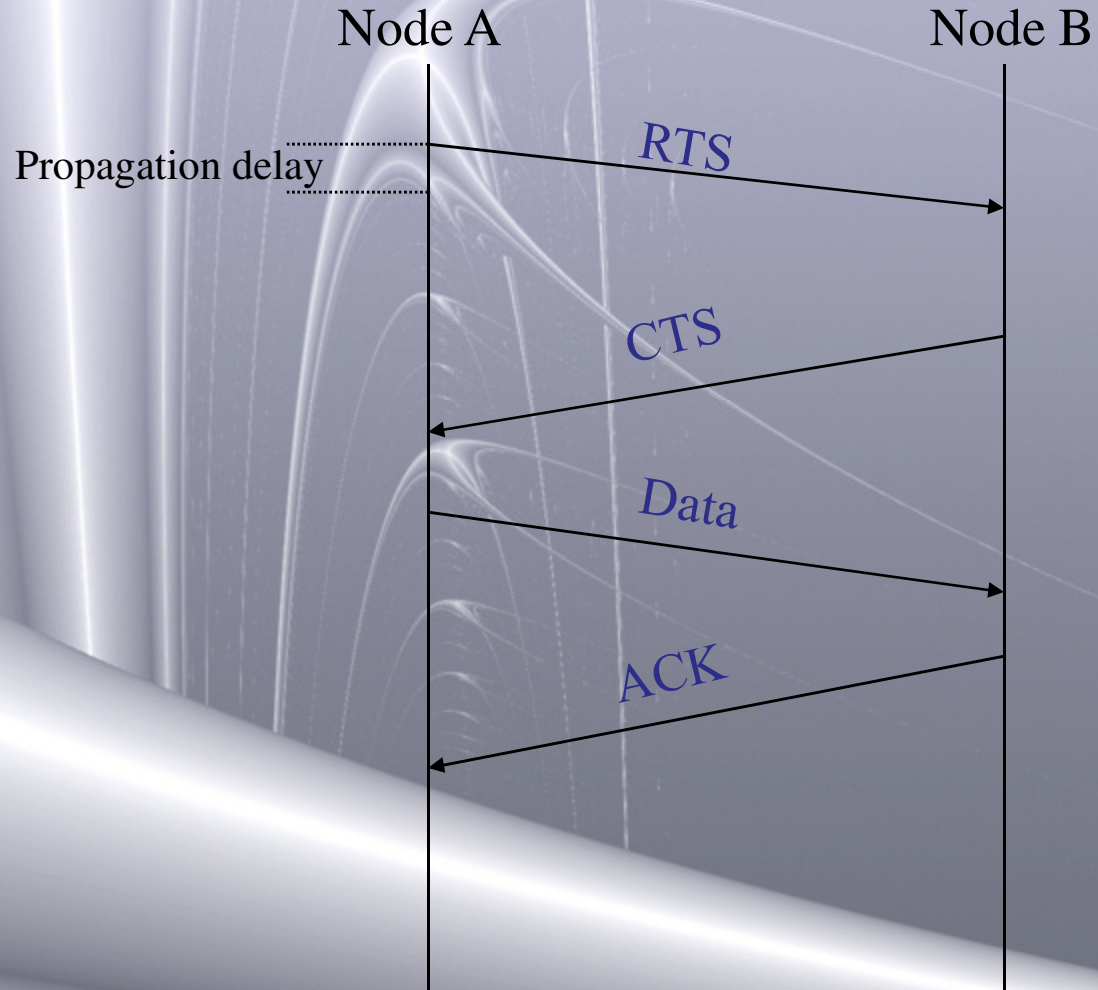

Summary of Concepts in this Chapter

- What are Logarithmic Units (dB) and the advantages we get by using them
- How we measure the Quality of the Service in data transmission
- Advantages and drawbacks of digital transmission
- Fundamentals of Communications networks topologies and technologies
- Main functionalities (blocks) of Analog Communications
- Main functionalities (blocks) of Digital Communications
- Multiplexing and Multiple Access